

About this Manual

We've added this manual to the Agilent website in an effort to help you support your product. This manual is the best copy we could find; it may be incomplete or contain dated information. If we find a more recent copy in the future, we will add it to the Agilent website.

Support for Your Product

Agilent no longer sells or supports this product. Our service centers may be able to perform calibration if no repair parts are needed, but no other support from Agilent is available. You will find any other available product information on the Agilent Test & Measurement website, www.tm.agilent.com.

HP References in this Manual

This manual may contain references to HP or Hewlett-Packard. Please note that Hewlett-Packard's former test and measurement, semiconductor products and chemical analysis businesses are now part of Agilent Technologies. We have made no changes to this manual copy. In other documentation, to reduce potential confusion, the only change to product numbers and names has been in the company name prefix: where a product number/name was HP XXXX the current name/number is now Agilent XXXX. For example, model number HP8648A is now model number Agilent 8648A.

JTACS/NTACS Cellular Tests
HP 11807A,E Option 007
Reference Guide
for the HP 8920A,B,D

HP Part No. 11807-90122
Printed in U. S. A.
August 1995

Rev B

Copyright © Hewlett-Packard Company 1995

**RESTRICTED
RIGHTS LEGEND**

Use, duplication or disclosure by the U. S. Government is subject to restrictions as set forth in subparagraph (c) (1) (ii) of the Rights in Technical Data and Computer Software Clause in DFARS 252.227-7013.

Hewlett-Packard Company
3000 Hanover Street
Palo Alto, CA 94304
U.S.A

Rights for non-DOD U. S. Government Departments and Agencies are as set forth in FAR 52.227-19 (c) (1, 2).

Contents

1 Product Description

HP 11807A,E Radio Test Software 16

Finding the Information You Need 20

Additional Services Available 21

Contents

A.14.00	2 Using the Software/HP 8920B, or HP 8920A FW Above Rev.
	Testing Overview 26
	Customizing Testing 32

Contents

3 Using the Software/HP 8920A FW Rev Below A.14.00

Testing Overview 60

Customizing Testing 66

4 Test, Parameter, and Pass/Fail Limit Descriptions

Introduction	90
TEST_01. CP Registration	91
TEST_02. CP Page	92
TEST_03. TX Frequency Error	93
TEST_04. TX Carrier Power	94
TEST_05. TX Peak Frequency Deviation	96
TEST_06. TX Audio Frequency Response	97
TEST_07. TX Audio Distortion	98
TEST_08. TX Signaling Tone/DST	99
TEST_09. TX FM Hum and Noise	100
TEST_10. TX SAT/DSAT	101
TEST_11. TX RVC Data Deviation	103
TEST_12. TX Compressor Response	106
TEST_13. TX Current Drain	107
TEST_14. RX Expander	110
TEST_15. RX Audio Frequency Response	111
TEST_16. RX Audio Distortion	112
TEST_17. RX Hum and Noise	113
TEST_18. RX SINAD	114

Contents

TEST_19. RX FVC Order Message Error Rate	116
TEST_20. CP Release	117
TEST_21. CP Origination	118
TEST_22. OT No Audio Functional	119
TEST_23. TX Quick General	120
TEST_24. RX Quick General	121
TEST_25. CP Flow Chart	122
TEST_26. TX Switch Channels	124
TEST_27. CP Hook Flash	125
TEST_28. TX DTMF Frequency Error	126
Test Parameter Descriptions	127
Parameter 1. AA Enter Ph#?	128
Parameter 2. AB AID Number	129
Parameter 3. AC MIN From?	130
Parameter 4. CP Control Channel	131
Parameter 5. CP DSAT Vector	132
Parameter 6. CP Prt RECC RVC Data	133
Parameter 7. CP SAT Tone	134
Parameter 8. RC Compandor Always On	135
Parameter 9. RT External Path Loss	136

Contents

Parameter 10. RT High Supply Voltage	137
Parameter 11. RT Low Supply Voltage	138
Parameter 12. RT Nominal Supply Voltage	139
Parameter 13. RT Test at Extreme Settings	140
Parameter 14. RT use DUPLEX OUT & ANT IN	141
Parameters 15-17. RX Audio Response Start, Step, and Stop Frequencies	142
Parameters 18-20. RX Expander Start, Step, and Stop Levels	143
Parameter 21. RX FVC Message Error Rate RF Level	144
Parameter 22. RX RF Level for Signaling	145
Parameter 23. RX RF Level for SINAD	146
Parameter 24. RX RF Level for SINAD at Extremes	147
Parameter 25. RX Set Audio Level	148
Parameter 26. RX Tolerance for Setting Audio Level	149
Parameters 27-29. TX Audio Response Start, Step, and Stop Frequencies	150
Parameter 30. TX Carrier Power Levels Tested	151
Parameters 31-33. TX Compressor Start, Step, and Stop Levels	152
Parameter 34. TX Current Drain Levels Tested	153
Parameter 35. TX De-emphasis	154
Parameter 36. TX Peak Frequency Deviation Step Frequency	155

Contents

Parameter 37. TX Pk Freq Dev 50 Hz HPF	156
Parameters 38-40. TX Switch Channels Start, Step, and Stop Channel	157
Parameter 41. TX TS Atten for Signaling	158
Parameter 42. TX Units for Power Meas	159
Parameter 43. TX Voltage for Compressor Zero Crossing	160
Parameter 44. TXT Trnsient/SS Data	161
Pass/Fail Limit Descriptions	162
Pass/Fail Limit 1. RX Audio Distortion	163
Pass/Fail Limit 2. RX Audio Rsp Dev From -6 dB/oct	164
Pass/Fail Limit 3. RX Expander Track Error	165
Pass/Fail Limit 4. RX Expander Zero Reference Level	166
Pass/Fail Limit 5. RX Hum and Noise	167
Pass/Fail Limit 6. RX NTACS Expander Zero Reference Level	168
Pass/Fail Limit 7. RX Order Message Error Rate (OMER)	169
Pass/Fail Limit 8. RX SINAD	170
Pass/Fail Limit 9. TX Audio Distortion	171
Pass/Fail Limit 10. TX Audio Response Dev From 6 dB/Oct	172
Pass/Fail Limits 11-18. TX Carrier Power @Levels 0-7	173
Pass/Fail Limit 19. TX Compressor Track Error dB	176

Contents

Pass/Fail Limit 20. TX Compressor Zero Reference Deviation	177
Pass/Fail Limit 21. TX Current Drain @Levels 0-3	178
Pass/Fail Limit 22. TX Current Drain @ Levels 4-7	179
Pass/Fail Limit 23. TX DTMF Frequency Error	180
Pass/Fail Limit 24. TX FM Hum and Noise	181
Pass/Fail Limit 25. TX Frequency Error	182
Pass/Fail Limit 26. TX NTACS Compressor Zero Reference Deviation	183
Pass/Fail Limit 27. TX NTACS DSAT Closure	184
Pass/Fail Limit 28. TX NTACS DSAT Deviation	185
Pass/Fail Limit 29. TX NTACS DSAT Phase Jitter	186
Pass/Fail Limit 30. TX NTACS Peak Frequency Deviation	187
Pass/Fail Limit 31. TX Peak Frequency Deviation	188
Pass/Fail Limit 32. TX SAT Deviation	189
Pass/Fail Limit 33. TX SAT Frequency Error	190
Pass/Fail Limit 34. TX Signaling Tone Deviation	191
Pass/Fail Limit 35. TX Signaling Tone Frequency	192
Pass/Fail Limit 36. TX Wideband Data Deviation	193
Pass/Fail Limit 37. TXT Wideband Data Deviation Transient	194

Contents

5 Reference (Alphabetical)

Conventions Used 196

Copying Files 197

Data Collection (Saving and Retrieving Test Results) 199

Disks 209

Exiting a Program 212

HP-IB Control Annunciators 213

Memory Cards 214

Parameters 220

Pass/Fail Limits (specifications) 222

Pausing or Stopping a TEST 224

Printing 225

Procedures 240

RAM 246

Saving Tests Results 247

Serial Port 248

Test Execution Conditions 250

USER Keys 252

6 Problem Solving

- If You Have a Problem Testing Your Radio 256
- If the test procedure doesn't run on a test set 257
- If the HP 11807A,E program was incorrectly loaded 258
- If the printer does not print the test results 259
- If you can't get the data-collection function to work 261
- If the cellular phone fails to obtain service 263
- If the cellular phone registers, but won't page 264
- If the cellular phone fails the audio tests 265
- If a cellular phone links up with a system, not the test set 266

Contents

Glossary 267

Contents

Index 271

Product Description

HP 11807A,E Radio Test Software

The HP 11807A,E Option 007, Radio Test Software is used for automated testing of cellular phones. Software is written on One-Time Programmable (OTP) memory cards shown below. The Test Set's built-in computer (operating with HP Instrument BASIC programming language) allows automated measurements for manual, quick-functional, or full-parametric testing.

- Manual, quick-functional and full-parametric testing of cellular phones is done using pre-written Test Procedures on each OTP memory card.
- Also, user-defined Test Procedures may be created to meet your radio-specific testing needs. The user-defined Test Procedures are saved onto the Static Random-Access Memory (SRAM) memory card which is provided with each HP 11807A,E option.

Materials Included in This Package

This package contains the following materials. Verify that all the materials are present and inspect them for damage. If a part is missing or appears to be damaged, contact your nearest Hewlett-Packard sales or service office.

- HP 11807A Option 007 Test Software (part number 11807-10007) or HP 11807E Option 007 Test Software (part number 11807-10026)
- SRAM memory card (uninitialized), for saving your own test procedures and results.
 - For HP 11807A, 32 Kbyte SRAM (part number HP 85700A).
 - For HP 11807E, 64 Kbyte SRAM (part number HP 83230A).
- HP 11807A,E Option 007 Software Reference Guide (part number 11807-90122)
- HP software product license agreement

Additional Equipment Required

The HP 11807A,E Option 007 software requires the Test Set to be configured with the following hardware:

- HP 8920A,B,D Option R04: Tone/Digital Signaling
- HP 8920A,B,D Option R05: 512k RAM Memory extension

Recommended Equipment

Other hardware configurations for your HP 8920A are recommended, but not required:

- HP 8920A,B,D Option R01: High-Stability Timebase
- HP 8920A,B,D Option R11: CCITT Weighting Filter (C-Message Weighting Filter, HP 8920A Option 013 may also be used in place of CCITT)
- HP 8920A,B,D Option R14: 6 kHz Bandpass Filter

External Power Supplies

An external dc power supply for the cellular phone can be configured to the Test Set in one of three ways:

1. A power supply or battery can be connected directly to the cellular phone.
2. A power supply can be connected to the rear-panel DC CURRENT MEASUREMENT banana-plug connectors. (This requires the HP 8920A Option 003, HP-IB/RS-232/Current Measurement.)
3. A power supply can be controlled by the HP 8920A when it's connected to the HP-IB connector. (This requires the HP 8920A Option 003, HP-IB/RS-232/Current Measurement.)

The following HP-IB programmable power supply families are supported: (which use SCPI commands)

HP 664xA
HP 665xA
HP 667xA
HP 668xA

NOTE: The HP 662xA and HP 663xA dc power supply families do not use SCPI commands and are not supported.

Ordering Upgrades

If your test set does not contain all of the required options you must update your instrument accordingly. Order the necessary upgrade kit(s) from your local Hewlett-Packard sales office. Regional sales offices are listed at the front of this manual.

Required Upgrades

- HP 8920A Option R05: 512 Kbyte RAM expansion retrofit kit

Recommended Upgrades

- HP 8920A,B Option R01: High-Stability Timebase retrofit kit
- HP 8920A,B Option R04: Tone/Digital Signaling retrofit kit
- HP 8920A,B Option R10: 400 Hz High-Pass Filter (HPF) retrofit kit (A maximum of two optional filters can be installed in your test set. If you already have two optional filters installed, one of them must be removed before installing this kit.)
- HP 8920A,B Option R11: CCITT Weighting Filter retrofit kit (A maximum of two optional filters can be installed in your test set. If you already have two optional filters installed, one of them must be removed before installing this kit.)

Available Tests:

The following tests can be performed with this software.

- CP Registration
- CP Page
- TX Frequency Error
- TX Carrier Power
- TX Peak Frequency Deviation
- TX Audio Frequency Response
- TX Audio Distortion
- TX Signaling Tone/DST
- TX FM Hum and Noise
- TX SAT/DSAT
- TX RVC Data Deviation
- TX Compressor Response
- TX Current Drain
- RX Expander
- RX Audio Frequency Response
- RX Audio Distortion
- RX Hum and Noise
- RX SINAD
- RX FVC Order Message Error Rate
- CP Release
- CP Origination
- OT No Audio Functional
- TX Quick General
- RX Quick General
- CP Flow Chart
- TX Switch Channels
- CP Hook Flash
- TX DTMF Frequency Error

For test, parameter, and pass/fail limit (specification) descriptions, see [chapter 4, "Test, Parameter, and Pass/Fail Limit Descriptions,"](#) on page 89.

Software Features

The following features simplify testing:

- While adjustments are being made, a large meter display and auditory feedback are provided.
- Results of tests and pass/fail indications are displayed on the test set's CRT, and can be printed, or collected in a disk drive, memory card, PC, or HP Palmtop computer.
- The software allows the operator to change the order of tests, pass/fail limits, test parameters, and equipment configurations.

Finding the Information You Need

This manual describes the setup and use of the HP 11807A,E Software with the HP 8920A,B,D Test Set. The book is arranged in self-contained chapters to provide the following information:

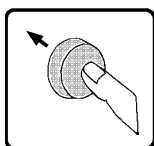

PRODUCT DESCRIPTION-CHAPTER 1

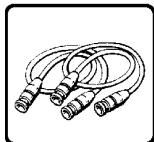

USING THE SOFTWARE-CHAPTER 2

- Instructions for cabling test set.
- How to load
- How to run
- How to customize

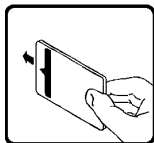

TEST DESCRIPTIONS-CHAPTER 4

Definitions, special conditions and restrictions for:

- Tests
- Pass/fail limits
- Parameters



REFERENCE-CHAPTER 5

- Alphabetically listed
- Detailed descriptions of all the features and functions of the software.
- For the advanced level user.



PROBLEM SOLVING-CHAPTER 6

- Alphabetically listed
- Symptoms and possible corrections to frequent user problems.

Additional Services Available

Consult the HP 8920 User's Guide or call the HP 8920 Hotline 1-800-922-8920 (in the USA and Canada only) and give your software model number.

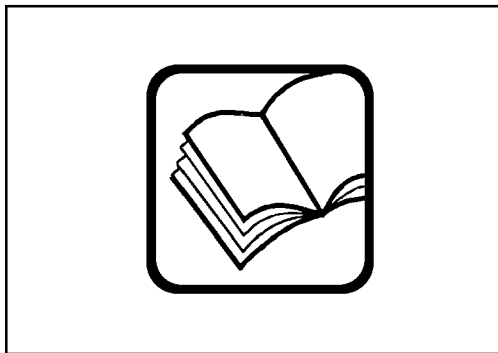

TROUBLE1



**Using the Software/HP 8920B, or HP
8920A FW Above Rev. A.14.00**

NOTE:

The firmware revision A.14.00 in the HP 8920A,D had several enhancements, which are standard in the HP 8920B. This chapter applies to users with:

- **HP 8920A test sets with firmware revision above A.14.00**
- **All HP 8920B test sets.**

The test set's firmware revision is displayed on the top right corner of the configuration screen.

- Press SHIFT CONFIG to display the configuration screen and read the firmware revision.

If you have an HP 8920A test set with firmware revision below A.14.00, refer to [chapter 3, "Using the Software/HP 8920A FW Rev Below A.14.00"](#). Contact Hewlett-Packard at 1-800-922-8920 for details on upgrading your firmware if desired.

The software can be run on the factory default settings or customized to your individual needs and specific requirements. This chapter provides detailed information on how to load, run, and customize the software.

The test set has two methods of accessing on-line help. In each of the screens in the test environment, k4 (**He1p**) accesses specific information about how to set up/use the current screen. SHIFT HELP accesses the master help file, with an alphabetical listing of help topics.

Testing Overview

Pressing TESTS will display what is called the **TESTS (Main Menu)** screen. To begin testing, you must first load the software and make connections. From this screen you have the option to:

Begin running tests:

- The factory default settings are acceptable for your application or
- The software has already been customized and saved to a memory card

Customize the software:

- Decide which tests you desire to run (Order of Tests)
 - you may want to run all, some, or just one of the tests.
- Specify which channels to test (Channel Information)
 - you may want to test one, some, or all of the channels on your radio.
- Change the pass/fail limits for specific measurements (Pass/Fail Limits)
 - you may want the pass/fail limits to have tighter or looser specifications than the default settings.
- Change the test environment and conditions (Test Parameters)
 - decide output format.
 - enter specific information about radio equipment and/or environment.
- Save any or all of the above customized changes to a memory card (Save/Delete Procedure)

Set Up Test Set:

- Print test results or certain screens.
- Decide when and where test results are displayed (**Execution Conditions/Printer Setup**)

To Run Tests

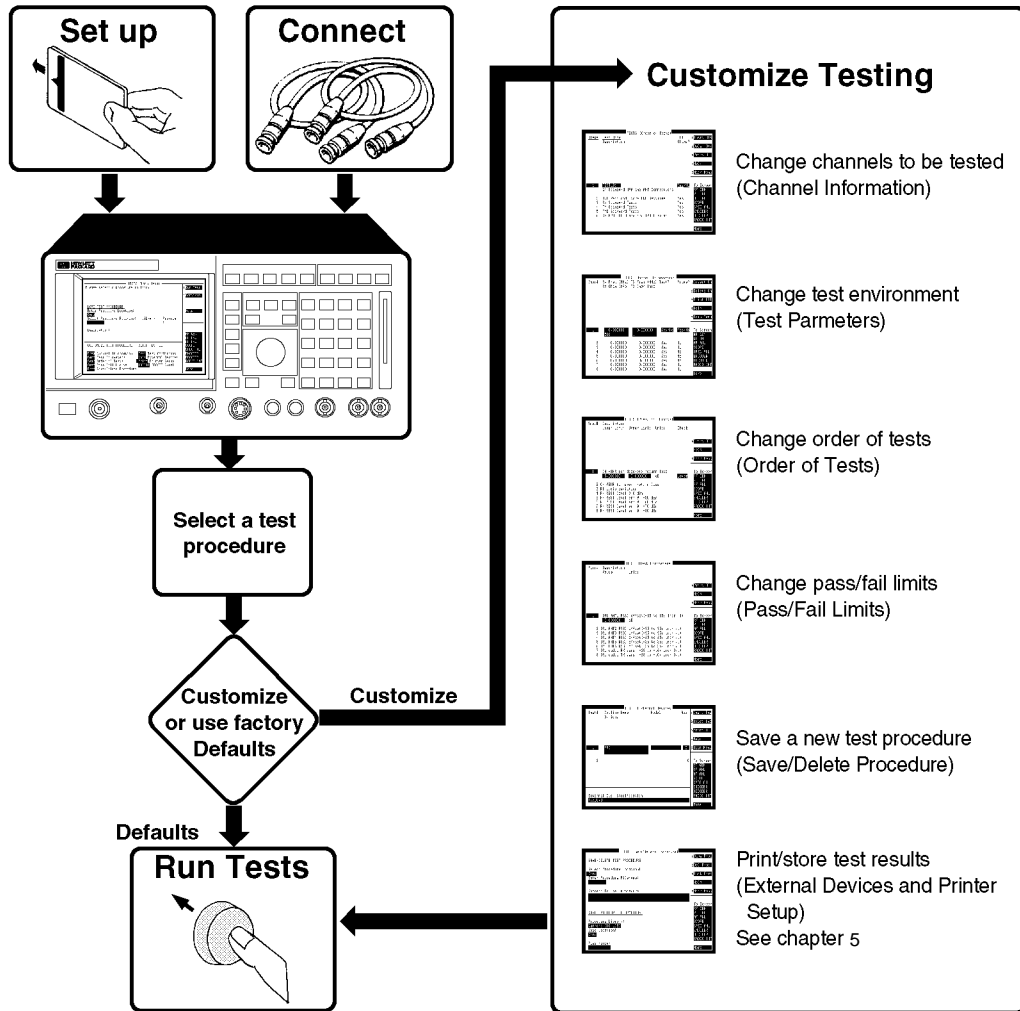

OVRVIEW1

Setting Up the Test Set and Making Connections

Before you begin testing, you must set up the test set and make the appropriate hardware connections.

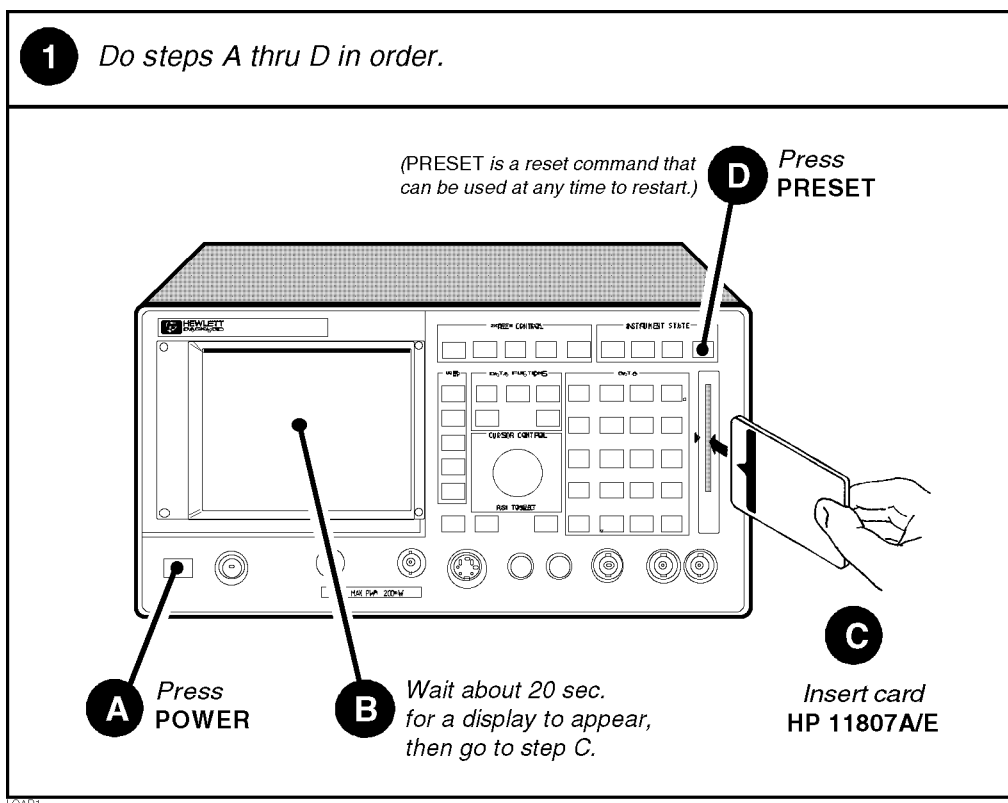

Making a Connection

2 Connect a radio to the test set.

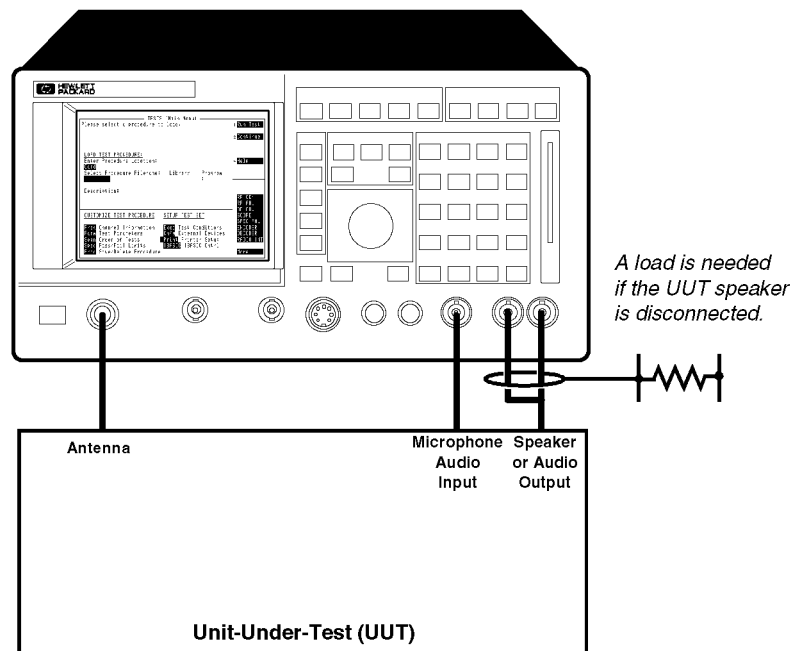

CONNECT1

Selecting a Test Procedure









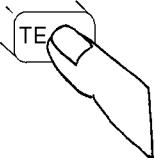

To load the software, you must first select the location to load from (in this case, it will be **Card**) and a procedure filename. Your card comes pre-programmed with at least one procedure. The actual software program does not get loaded into the test set's memory until k1 (**Run Test**) is selected. It will take approximately 15 seconds to load the software in an HP 8920B, and approximately two minutes in an HP 8920A,D.

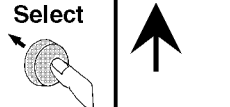
The software memory card can be removed after the program is loaded into the test set's memory. The program will remain in memory after a power-down/ power-up cycle, unless it is manually deleted or a new program is loaded.

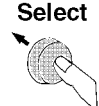
When tests begin to run, they are executed in the order in which they were entered into the Test Procedure.

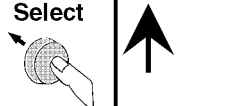
Pressing CANCEL will pause the current test (press k2 to continue the test.)

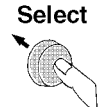
Selecting A Test Procedure

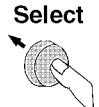
<p>1 Press TESTS to display the TESTS screen.</p>	<p>2 Position cursor and select Select Procedure Location:.</p>								
<p>If you are in <i>IBASIC</i>, press <i>SHIFT, CANCEL</i> before pressing <i>TESTS</i>.</p> 	<p>Position</p>  <p>Select Procedure Location:</p>  <p>Select</p>								
<p>3 Position cursor and select Card.</p>	<p>4 Position cursor and select Select Procedure Filename:.</p>								
<p>Position</p>  <p>Select</p>  <table border="1" data-bbox="592 1029 738 1239"> <tr><td>Choices :</td></tr> <tr><td><input checked="" type="checkbox"/> Card</td></tr> <tr><td><input type="checkbox"/> ROM</td></tr> <tr><td><input type="checkbox"/> RAM</td></tr> <tr><td><input type="checkbox"/> Disk</td></tr> </table>	Choices :	<input checked="" type="checkbox"/> Card	<input type="checkbox"/> ROM	<input type="checkbox"/> RAM	<input type="checkbox"/> Disk	<p>Position</p>  <p>Select Procedure Filename:</p>  <p>Select</p>			
Choices :									
<input checked="" type="checkbox"/> Card									
<input type="checkbox"/> ROM									
<input type="checkbox"/> RAM									
<input type="checkbox"/> Disk									
<p>5 Position cursor and select desired Procedure.</p>	<p>6 Position cursor and select Run Test.</p>								
<p>Position</p>  <p>Select</p>  <table border="1" data-bbox="592 1394 738 1604"> <tr><td>Choices :</td></tr> <tr><td><input checked="" type="checkbox"/> XXXXXX</td></tr> <tr><td><input type="checkbox"/> XXXXXX</td></tr> <tr><td><input type="checkbox"/> XXXXXX</td></tr> <tr><td><input type="checkbox"/> XXXXXX</td></tr> </table>	Choices :	<input checked="" type="checkbox"/> XXXXXX	<input type="checkbox"/> XXXXXX	<input type="checkbox"/> XXXXXX	<input type="checkbox"/> XXXXXX	<p>Position</p>  <p>Select</p>  <table border="1" data-bbox="1177 1415 1323 1604"> <tr><td><input checked="" type="checkbox"/> Run Test</td></tr> <tr><td><input type="checkbox"/> 2 Continue</td></tr> <tr><td><input type="checkbox"/> 4 Help</td></tr> </table> <p>8920A,D ≈ 2 min. 8920B ≈ 15 sec.</p>	<input checked="" type="checkbox"/> Run Test	<input type="checkbox"/> 2 Continue	<input type="checkbox"/> 4 Help
Choices :									
<input checked="" type="checkbox"/> XXXXXX									
<input type="checkbox"/> XXXXXX									
<input type="checkbox"/> XXXXXX									
<input type="checkbox"/> XXXXXX									
<input checked="" type="checkbox"/> Run Test									
<input type="checkbox"/> 2 Continue									
<input type="checkbox"/> 4 Help									

PROCEED1

Customizing Testing

Because of the diversity of individual testing needs, the software has been designed so that changes may be easily made from the test set's front panel. You may store these changes on a memory card so that you may skip these steps in the future. See "[Saving a Test Procedure](#)" on page 50.

Because your needs change, the software allows changes to its default settings whenever you need to make them. For example, tests may be inserted or deleted, and later after running the tests you can change the pass/fail limits or decide to test different channels.

Most testing customization is accomplished through the customization screens. These customization screens are accessed from the main **TESTS (Main Menu)** screen as shown in the following figure. Customizing procedures is explained later in this chapter.

NOTE: External Devices, Printer Setup, and IBASIC will not be explained in this customizing section.

- External Devices and Printer Setup are used when setting up printers and external disk drives which is explained in *Disks* and *Printing* in chapter 4.
- IBASIC is used when writing your own programs and is not explained in this manual. If you need to write your own IBASIC programs you may acquire the following manuals:
 - HP 8920A,D
 - *HP Instrument Basic User's Handbook* HP part number E2083-90000.
 - *HP 8920A Programming Manual* HP part number 08920-90220.
 - HP 8920B
 - *HP Instrument Basic User's Handbook Version 2.0* HP part number E2083-90005.
 - *HP 8920B Programming Manual* HP part number 08920-90222.

How to Customize Testing

TESTS Screen

TESTS (Main Menu)

Please select a procedure to load.

1 Run Test
2 Continue
4 Help

LOAD TEST PROCEDURE:
Select Procedure Location:
Card
Select Procedure Filename: Library: Program:
Description:

CUSTOMIZE TEST PROCEDURE: SET UP TEST SET:

Freq Channel Information	Exec Execution Cond
Parm Test Parameters	Cnfg External Devices
Seqn Order of Tests	Print Printer Setup
Spec Pass/Fail Limits	IBASIC IBASIC Cntrl
Proc Save/Delete Procedure	

To Screen
RF GEN
RF ANL
AF ANL
SCOPE
SPEC ANL
ENCODER
DECODER
RADIO INT
More

Selecting a Test Function opens a Customization Screen.

CUSTOM1

Changing the Order of Tests











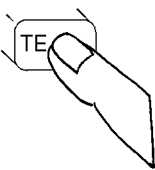







You may define the order of tests to include all, some, or just one of the tests available. When the first test is finished, the next will run. The test sequence will remain in the test set's battery backed-up memory until another test sequence is loaded or set up. For information on saving a customized test sequence, see ["Saving a Test Procedure" on page 50](#).

Defining the order of tests is accomplished by inserting or deleting tests from the list of tests that come with the software package. See [chapter 4, "Test, Parameter, and Pass/Fail Limit Descriptions"](#), for descriptions of tests included in this package.

The **All Chans?** field allows the user to decide to run the test on all channels entered in the **Channel Information** table, or just the channels which are selected as **Prime** in the **Channel Information** screen. This feature allows the user the flexibility to use channels that are selected as **Prime** in all the tests in the sequence, and those indicated as non-prime in a subset of tests (those tests with a **Yes** response in **All Chans**). For more information, see ["Specifying Channel Information" on page 38](#).

The following describes how to create a new test sequence and enter a response to the **All Chans?** field.



How to Change the Order of Tests

<p>1 Press TESTS to display the TESTS (Main Menu) screen.</p> <p><i>If you are in IBASIC, press SHIFT, CANCEL before pressing TESTS.</i></p> 	<p>2 Position cursor and select Seqn Order of Tests.</p> <table border="1"> <tr> <td data-bbox="852 556 982 787"> <p>Position</p>  <p>Select</p>  </td> <td data-bbox="990 556 1339 787"> <table border="1"> <tr><td>Freq</td><td>Channel Information</td></tr> <tr><td>Parm</td><td>Test Parameters</td></tr> <tr><td>Seqn</td><td>Order of Tests</td></tr> <tr><td>Spec</td><td>Pass Fail Limits</td></tr> <tr><td>Proc</td><td>Save/Delete Procedure</td></tr> </table> </td> </tr> </table>	<p>Position</p>  <p>Select</p> 	<table border="1"> <tr><td>Freq</td><td>Channel Information</td></tr> <tr><td>Parm</td><td>Test Parameters</td></tr> <tr><td>Seqn</td><td>Order of Tests</td></tr> <tr><td>Spec</td><td>Pass Fail Limits</td></tr> <tr><td>Proc</td><td>Save/Delete Procedure</td></tr> </table>	Freq	Channel Information	Parm	Test Parameters	Seqn	Order of Tests	Spec	Pass Fail Limits	Proc	Save/Delete Procedure
<p>Position</p>  <p>Select</p> 	<table border="1"> <tr><td>Freq</td><td>Channel Information</td></tr> <tr><td>Parm</td><td>Test Parameters</td></tr> <tr><td>Seqn</td><td>Order of Tests</td></tr> <tr><td>Spec</td><td>Pass Fail Limits</td></tr> <tr><td>Proc</td><td>Save/Delete Procedure</td></tr> </table>	Freq	Channel Information	Parm	Test Parameters	Seqn	Order of Tests	Spec	Pass Fail Limits	Proc	Save/Delete Procedure		
Freq	Channel Information												
Parm	Test Parameters												
Seqn	Order of Tests												
Spec	Pass Fail Limits												
Proc	Save/Delete Procedure												
<p>The Order of Tests screen is now present on your CRT.</p>	<p>3 Position cursor and select Step # field.</p> <table border="1"> <tr> <td data-bbox="852 913 982 1144"> <p>Position</p>  <p>Select</p>  </td> <td data-bbox="990 913 1339 1144"> <p>Example</p> <table border="1"> <tr> <td>"1"</td> <td>"TEST 5"</td> </tr> <tr> <td>↑</td> <td>"Test name"</td> </tr> </table> </td> </tr> </table>	<p>Position</p>  <p>Select</p> 	<p>Example</p> <table border="1"> <tr> <td>"1"</td> <td>"TEST 5"</td> </tr> <tr> <td>↑</td> <td>"Test name"</td> </tr> </table>	"1"	"TEST 5"	↑	"Test name"						
<p>Position</p>  <p>Select</p> 	<p>Example</p> <table border="1"> <tr> <td>"1"</td> <td>"TEST 5"</td> </tr> <tr> <td>↑</td> <td>"Test name"</td> </tr> </table>	"1"	"TEST 5"	↑	"Test name"								
"1"	"TEST 5"												
↑	"Test name"												
<p>4 Rotate knob until Step # which precedes the insertion point of the new test you are adding is highlighted, then select it.</p> <table border="1"> <tr> <td data-bbox="344 1281 462 1522"> <p>Rotate</p>  <p>Select</p>  </td> <td data-bbox="470 1281 1339 1522"> <p><i>For example, select step 7 if you want to insert the new test as step 8.</i></p> <table border="1"> <tr> <td>"7"</td> <td>"TEST #"</td> </tr> <tr> <td>↻</td> <td>"Test name"</td> </tr> <tr> <td>"8"</td> <td>"New test"</td> </tr> </table> </td> </tr> </table>	<p>Rotate</p>  <p>Select</p> 	<p><i>For example, select step 7 if you want to insert the new test as step 8.</i></p> <table border="1"> <tr> <td>"7"</td> <td>"TEST #"</td> </tr> <tr> <td>↻</td> <td>"Test name"</td> </tr> <tr> <td>"8"</td> <td>"New test"</td> </tr> </table>	"7"	"TEST #"	↻	"Test name"	"8"	"New test"					
<p>Rotate</p>  <p>Select</p> 	<p><i>For example, select step 7 if you want to insert the new test as step 8.</i></p> <table border="1"> <tr> <td>"7"</td> <td>"TEST #"</td> </tr> <tr> <td>↻</td> <td>"Test name"</td> </tr> <tr> <td>"8"</td> <td>"New test"</td> </tr> </table>	"7"	"TEST #"	↻	"Test name"	"8"	"New test"						
"7"	"TEST #"												
↻	"Test name"												
"8"	"New test"												



SEQ1

Continue on next page



5 Position cursor and select **Insrt Stp**.

<p>Position</p>  <p>Select</p> 	 <div style="border: 1px solid black; padding: 5px; width: fit-content;"> <p>■ Insrt Stp</p> <p>2 Delet Stp</p> <p>3 Print All</p> <p>4 Edit Freq</p> <p>5 Edit Spec</p> </div>
---	--



6 Position cursor back at **Step #** field and select it.

<p>Position</p>  <p>Select</p> 	<div style="display: flex; align-items: center; gap: 20px;"> <div style="border: 1px solid black; padding: 2px 5px;">"7"</div> <div style="border: 1px solid black; padding: 2px 5px;">"TEST #"</div> </div> <p>"Test name"</p> 
---	---



7 Highlight and select **Step #** field of newly inserted test.

<p>Highlight</p>  <p>Select</p> 	<div style="display: flex; align-items: center; gap: 20px;"> <div style="border: 1px solid black; padding: 2px 5px;">"8"</div> <div style="border: 1px solid black; padding: 2px 5px;">"TEST #"</div> </div> <p>"Test name"</p> 
---	---



8 Position cursor and select **Test Name** field.

<p>Position</p>  <p>Select</p> 	<div style="display: flex; align-items: center; gap: 20px;"> <div style="border: 1px solid black; padding: 2px 5px;">"8"</div> <div style="border: 1px solid black; padding: 2px 5px;">"TEST #"</div> </div> <p>"Test name"</p> 
--	---

9 Rotate knob and select desired **Test Name** when it appears.

<p>Rotate</p>  <p>Select</p> 	<div style="display: flex; align-items: center; gap: 20px;"> <div style="border: 1px solid black; padding: 2px 5px;">"##"</div> <div style="border: 1px solid black; padding: 2px 5px;">"TEST #"</div> </div> <p>"Test name"</p> 
---	--

10 Position cursor at **All Chans?** field and select **Yes** or **No**.

<p>Position</p>  <p>Select</p> 	<div style="border: 1px solid black; padding: 5px; display: inline-block;">Yes/No</div> <p>(Press the knob to change the selection.)</p> 
---	---

SEQ2

Continue on next page

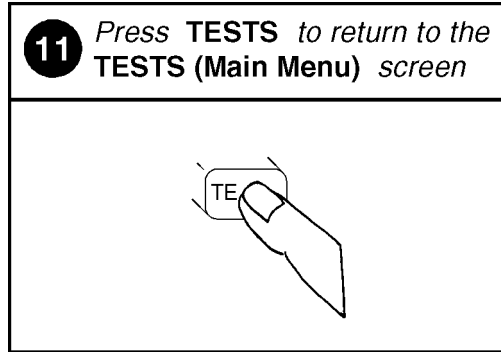

SEQ3

Specifying Channel Information

For each channel that you wish to specify, you must enter the following information into the Channel Information screen:

- Cell Channel
 - Enter the cell channel number.
- Options
 - For the last channel that you want tested in the **Channel Information** table, select **Options** and using the characters in the **Choices** menu enter **END**. This will speed up the testing time (so the software will not scan through the entries that are blank in the **Channel Information** screen).
- **Test?** (yes/no) specifies whether you want to test the UUT at this channel. If set to “No” then the UUT will not be tested at that channel, but you may retain the channel information in the table for later use. If set to “Yes” then the channel will be used as defined by settings of **Prime?** and **All Chans?** fields.
- **Prime?** (yes/no) specifies which channels are “prime”. Select “Yes” if you want to test the UUT at this channel on all the tests in the procedure. Select **No** if you want to test the UUT at this channel on just a subset of tests, which are designated by selecting **Yes** in the **All Chans** field of the **Order of Tests** screen. See **All Chans?** in "[Changing the Order of Tests](#)" on page 34 for more information.

For information on saving the channel information table, see "[Saving a Test Procedure](#)" on page 50.

The **All Chans** field in the **Order of Tests** screen interacts closely with the **Prime?** field on the **Channel Information** screen. When the software runs, it begins by retrieving the first channel entered into the **Channel Information** screen. It then checks the response in the **Test?** field to determine if the UUT should be tested at that channel at this time. If there is a **No** response in the **Test?** field, the software will go to the next channel in the table. If there is a **Yes** response in the **Test?** field, the software will check if the channel is **Prime**.

A **Yes** response in the **Prime?** field indicates to test the UUT at that channel on the entire sequence of tests in the procedure. A **No** response in the **Prime?** field indicates to test the UUT at that channel on a subset of tests in the procedure. The subset of tests is determined by a **Yes** response in the **All Chans?** field. Therefore, tests with a **No** response in the **All Chans?** field will be run on *prime* channels only.

Below is an example of how the software would run if you had a procedure set up as follows:

Chan #	Test?	Prime?
Chan 01	Yes	Yes
Chan 02	Yes	No
Chan 03	No	No

Test Number	All Chan? Setting
Test 01	No
Test 02	Yes
Test 03	Yes
Test 04	No

The result would be:

- Chan 01 is used in Test 01, Test 02, Test 03, and Test 04.
- Chan 02 is used in Test 02, and Test 03 only.
- Chan 03 is not used.

The following table shows how to properly configure these settings according to your testing needs.

Testing Need	Necessary Field Settings		
	Test?	Prime?	All Chan?
Test channel on all tests in sequence	Yes	Yes	Don't Care
Test channel on a subset of tests in sequence	Yes	No	Yes on tests you want included in the testing subset
Do not test this channel now, but retain information for later use	No	Don't Care	Don't Care

How to Specify Channel Information

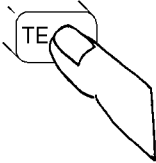
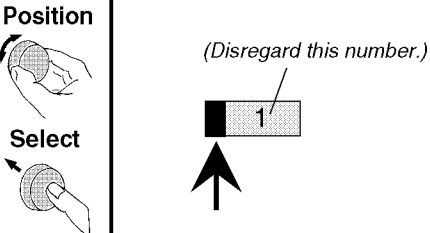
<p>1 Press TESTS to display the TESTS (Main Menu) screen.</p> <p><i>IF you are in IBASIC, press SHIFT, CANCEL before pressing TESTS.</i></p> 	<p>2 Position cursor and select Freq Channel Information.</p> <table border="1"> <tr> <td>Position</td> <td></td> </tr> <tr> <td></td> <td>Freq Channel Information</td> </tr> <tr> <td>Select</td> <td>Parm Test Parameters</td> </tr> <tr> <td></td> <td>Seqn Order of Tests</td> </tr> <tr> <td></td> <td>Spec Pass Fail Limits</td> </tr> <tr> <td></td> <td>Proc Save/Delete Procedure</td> </tr> </table>	Position			Freq Channel Information	Select	Parm Test Parameters		Seqn Order of Tests		Spec Pass Fail Limits		Proc Save/Delete Procedure						
Position																			
	Freq Channel Information																		
Select	Parm Test Parameters																		
	Seqn Order of Tests																		
	Spec Pass Fail Limits																		
	Proc Save/Delete Procedure																		
<p>The Channel Information screen is now present on your CRT.</p>	<p>3 Position cursor and select Entry # field.</p> <p><i>(Disregard this number.)</i></p> 																		
<p>4 Scroll to and select desired Entry #.</p> <p><i>(These numbers are examples.)</i></p> <table border="1"> <tr> <td>Scroll</td> <td></td> <td></td> <td></td> </tr> <tr> <td>Select</td> <td></td> <td></td> <td></td> </tr> </table>	Scroll				Select				<p>5 Position cursor and select Cell Channel field.</p> <table border="1"> <tr> <td>Position</td> <td></td> <td></td> <td></td> <td></td> </tr> <tr> <td>Select</td> <td></td> <td></td> <td></td> <td></td> </tr> </table>	Position					Select				
Scroll																			
Select																			
Position																			
Select																			

FREQ1

Continue on next page

6 Use **DATA** keys to enter new Cell Channel, then select it.

Enter

Select

6 "New #"
 (Enter your desired Cell Channel number)

7 Position cursor at **Test?** field and select **Yes** or **No**.

Position

Select

Yes/No
 (Press knob to change the selection.)

8 Position cursor at **Prime?** field and select **Yes** or **No**.

Position



Select



Yes/No
 (Press knob to change the selection.)

Repeat steps 3-8 for each Cell Channel you are entering. When you have completed entering all channels, go to step 9.

9 Position cursor and select **Options** field.

Position

Select

#.#####

10 Select these characters: **E N D**, then select **Done**.

Position

Select

Choices :
 Done
 Position
 Over/Ins
 Delete
 Del End
 Bk space
 A
 B
 C

Continue on next page

FREQ2

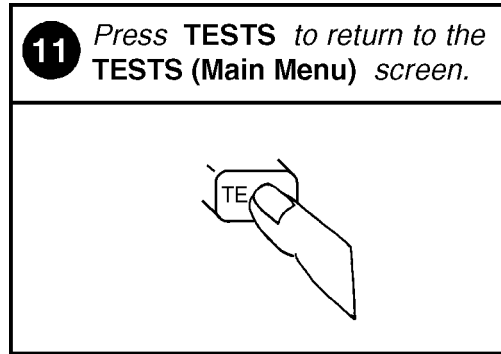

FREQ3

Changing Pass/Fail Limits

Pass/Fail limits define the values a measurement's result is compared against to determine if the UUT meets its specified standards. Default values are set in the test software. These default values may be changed to suit your particular requirements.





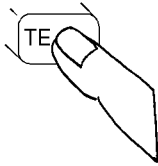
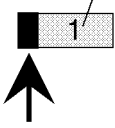

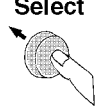
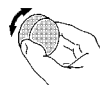
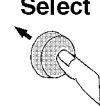

The following describes how to change the pass/fail (upper and lower) limits. See "[Pass/Fail Limit Descriptions](#)" on page 162 in [chapter 4](#) for descriptions of each pass/fail limit. For information on saving customized pass/fail limits, see "[Saving a Test Procedure](#)" on page 50.

How to Change Pass/Fail Limits

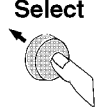
<p>1 Press TESTS to display the TESTS screen.</p> <p><i>IF you are in IBASIC, press SHIFT, CANCEL before pressing TESTS.</i></p> 	<p>2 Position cursor and select Spec Pass Fail Limits.</p> <table border="1"> <tr> <td>Position</td> <td></td> </tr> <tr> <td>Select</td> <td></td> </tr> </table> <table border="1"> <tr> <td>Freq</td> <td>Channel Information</td> </tr> <tr> <td>Parm</td> <td>Test Parameters</td> </tr> <tr> <td>Seqn</td> <td>Order of Tests</td> </tr> <tr> <td>Spec</td> <td>Pass Fail Limits</td> </tr> <tr> <td>Proc</td> <td>Save/Delete Procedure</td> </tr> </table>	Position		Select		Freq	Channel Information	Parm	Test Parameters	Seqn	Order of Tests	Spec	Pass Fail Limits	Proc	Save/Delete Procedure
Position															
Select															
Freq	Channel Information														
Parm	Test Parameters														
Seqn	Order of Tests														
Spec	Pass Fail Limits														
Proc	Save/Delete Procedure														
<p>The Pass Fail Limits screen is now present on your CRT.</p>	<p>3 Position cursor and select Spec # field.</p> <table border="1"> <tr> <td>Position</td> <td></td> </tr> <tr> <td>Select</td> <td></td> </tr> </table> <p>(Disregard this number.)</p> 	Position		Select											
Position															
Select															

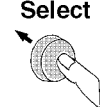

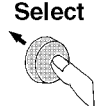
SPEC1

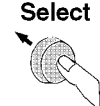
Continue on next page

<p>4 Scroll to and select desired Spec #.</p>	<p>5 Position cursor and select Lower limit field.</p>
<p>Scroll  <i>(This Spec # is an example.)</i>  6 FCC TX output p -1.000000 1.</p>	<p>Position  6 FCC TX output p  -1.000000 1.</p>
<p>6 Use DATA keys to enter new value, then select it.</p>	<p>7 Position cursor and select Upper Limit field.</p>
<p>Enter  6 FCC TX output p  -0.500000 1. <i>(Enter your desired value.)</i></p>	<p>Position  C TX output power adjustme .500000  1.000000 dB</p>
<p>8 Use DATA keys to enter new value, then select it.</p>	<p>9 Position cursor and select Check field.</p>
<p>Enter  C TX output power adjustme .500000  0.500000 dB <i>(Enter your desired value.)</i></p>	<p>Position   Both</p>

SPEC2

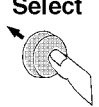
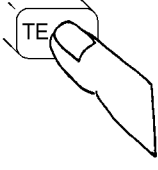
Continue on next page

10 <i>Position cursor and select Both .</i>		11 <i>Press TESTS to return to the TESTS (Main Menu) screen.</i>						
Position 		Select 						
		<table border="1"><tr><td>Choices :</td></tr><tr><td>Upper</td></tr><tr><td>Lower</td></tr><tr><td><input checked="" type="checkbox"/> Both</td></tr><tr><td>None</td></tr></table>	Choices :	Upper	Lower	<input checked="" type="checkbox"/> Both	None	
Choices :								
Upper								
Lower								
<input checked="" type="checkbox"/> Both								
None								







SPEC3

Changing the Test Parameters

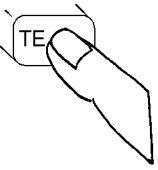
The software uses parameters to optimize the test environment and conditions for your testing situation. Many of the test parameters are determined by examining your test needs. The software comes with default settings for test parameters. Review the defaults for your particular needs. See "[Test Parameter Descriptions](#)" on page 127 in [chapter 4](#) for descriptions of each test parameter. For information on saving customized test parameters, see "[Saving a Test Procedure](#)" on page 50.













The following describes how you can change test parameters through the Test Parameter screen to optimize your testing conditions.

How to Change the Test Environment and Conditions

1 Press TESTS to display the TESTS (Main Menu) screen.	2 Position cursor and select Parm Test Parameters.				
<p><i>If you are in IBASIC, press SHIFT, CANCEL before pressing TESTS.</i></p> 	<table border="1"><tr><td data-bbox="803 961 927 1073">Position </td><td data-bbox="927 961 1294 1073">Freq Channel Information</td></tr><tr><td data-bbox="803 1073 927 1203">Select </td><td data-bbox="927 1073 1294 1203">Parm Test Parameters Seqn Order of Tests Spec Pass Fail Limits Proc Save/Delete Procedure</td></tr></table>	Position 	Freq Channel Information	Select 	Parm Test Parameters Seqn Order of Tests Spec Pass Fail Limits Proc Save/Delete Procedure
Position 	Freq Channel Information				
Select 	Parm Test Parameters Seqn Order of Tests Spec Pass Fail Limits Proc Save/Delete Procedure				

PARM1

Continue on next page

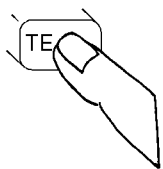
<p>The Tests Parameters screen is now present on your CRT.</p>	<p>3 Position cursor and select Parm # field.</p> <p>Position  Select </p> <p>(Entries on your display may be different.)</p> <p>1 RT audio test to 0.000000</p> <p></p>
<p>4 Scroll to and select Parm # to be changed.</p> <p>Scroll  Select </p> <p>(This parameter number and description are examples.)</p> <p>15 TX cable loss </p>	<p>5 Position cursor and select Value field.</p> <p>Position  Select </p> <p>15 TX cable loss 0.000000 </p>
<p>6 Use DATA keys to enter new value, then select it.</p> <p>Enter  Select </p> <p>15 TX cable loss 1.000000  (Enter your desired value.)</p>	<p>7 Press TESTS to return to the TESTS (Main Menu) screen.</p> <p></p>

PAPM2











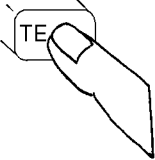

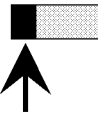

Saving a Test Procedure

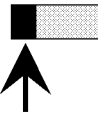
A Test Procedure is a collection of channel information, test parameters, testing order, and pass/fail limits saved in a file that customizes the test software to a specific application. You may save the file to a memory card or disk.

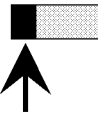
When you save a procedure you will be saving channel information, test parameters, pass/fail limits, and testing order, plus a library that contains the names of all test parameters, pass/fail limits, and tests that are resident in the software. The library file comes from the software and cannot be modified. The library file will be automatically saved on the card or disk that is being used to store the new test procedure.

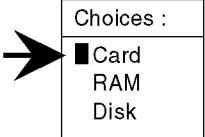

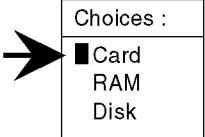
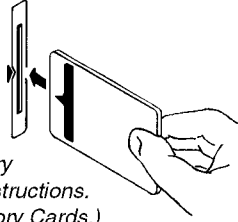

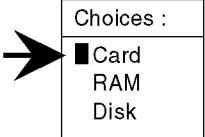







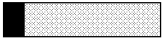









The following example shows how to save a new procedure to a memory card. For more information concerning procedures, see ["Procedures" on page 240](#) in the [chapter 5, "Reference \(Alphabetical\)"](#).

How to Save a Test Procedure

<p>1 Press TESTS to display the TESTS (Main Menu) screen.</p> <p><i>If you are in IBASIC, press SHIFT, CANCEL before pressing TESTS.</i></p> 	<p>2 Position cursor and select Proc Save/Delete Prodedure.</p> <table border="1"> <tr> <td>Position</td> <td></td> </tr> <tr> <td></td> <td>Freq Channel Information</td> </tr> <tr> <td></td> <td>Parm Test Parameters</td> </tr> <tr> <td></td> <td>Seqn Order of Tests</td> </tr> <tr> <td></td> <td>Spec Pass Fail Limits</td> </tr> <tr> <td>Select</td> <td>Proc Save/Delete Procedure</td> </tr> </table>	Position			Freq Channel Information		Parm Test Parameters		Seqn Order of Tests		Spec Pass Fail Limits	Select	Proc Save/Delete Procedure
Position													
	Freq Channel Information												
	Parm Test Parameters												
	Seqn Order of Tests												
	Spec Pass Fail Limits												
Select	Proc Save/Delete Procedure												
<p><i>The Save/Delete Procedure screen is now present on your CRT.</i></p>	<p>3 Position cursor and select Select Procedure Location.</p> <table border="1"> <tr> <td>Position</td> <td>Select Procedure Location:</td> </tr> <tr> <td></td> <td></td> </tr> <tr> <td>Select</td> <td></td> </tr> </table>	Position	Select Procedure Location:			Select							
Position	Select Procedure Location:												
													
Select													
<p>4 Position cursor and select Card.</p> <table border="1"> <tr> <td>Position</td> <td>Choices :</td> </tr> <tr> <td></td> <td></td> </tr> <tr> <td>Select</td> <td></td> </tr> </table> <p><i>(You can also save procedures to an internal RAM disk or external disk drive. See chapter 5-Disks.)</i></p>	Position	Choices :			Select		<p>5 Insert an initialized SRAM memory card.</p>  <p><i>(For detailed memory card initialization instructions, see chapter 5-Memory Cards.)</i></p>						
Position	Choices :												
													
Select													

PROCMAN1

Continue on next page

<p>6 <i>Position cursor and select</i> Enter Procedure Filename:.</p> <p>Position </p> <p>Select </p> <p>Enter Procedure Filename: </p> <p></p>	<p>7 <i>Select characters to name the procedure, then select Done.</i></p> <p>Position </p> <p>Select </p> <p>Choices : Done Position Over/Ins Delete Del End Bk space A B C</p> <p> </p>
<p>8 <i>Position cursor and select</i> Enter Description for new</p> <p>Position </p> <p>Select </p> <p>Enter Description for n </p> <p></p>	<p>9 <i>Select characters for the description, then select Done.</i></p> <p>Position </p> <p>Select </p> <p>Choices : Done Position Over/Ins Delete Del End Bk space A B C</p> <p> </p>
<p>10 <i>Position cursor at Procedure Library: and select Current.</i></p> <p>Position </p> <p>Select </p> <p>Procedure Library:  Current / [NO LIB]</p> <p> </p> <p><i>(The underline indicates which option is selected. Pressing knob changes the selection.)</i></p>	<p>11 <i>Position cursor and select</i> Code Location:.</p> <p>Code Location: </p> <p></p>

PROCMA12

Continue on next page

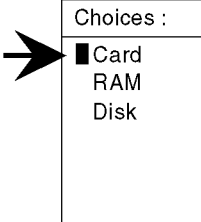
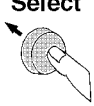
12 Position cursor at Card and select it.	
Position 	
Select 	

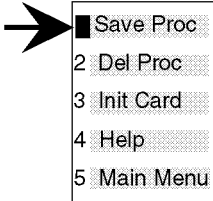
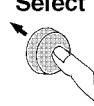
13 Position cursor at Save Proc and select it.	
Position 	
Select 	

14 Press **TESTS** to return to the **TESTS (Main Tests)** screen.

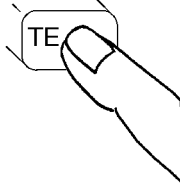

15 To run the saved procedure, follow the instructions below.

- 1) Insert the RAM card with your saved procedure.
- 2) On the **TESTS (Main Menu)** screen, a) position cursor and select **Select Procedure Location:**, then select **Card**, b) position cursor and select **Select Procedure Filename:**, then select your saved file name.
- 3) Remove your RAM card and insert the original HP 11807B ROM memory card.
- 4) Press **Run Test** .

The original card contains the full program needed to run your procedure.

PPOCM3a

Changing Test Execution Conditions

Test Execution Conditions define where and when test output occurs. You may decide to:

- Display output on CRT only, or display on CRT and print hardcopy (**Output Results To**).

NOTE:

If printing test results is desired, after selecting **Printer**, additional steps are necessary to connect and configure the printer. See "**Printing**" on page 225 in **chapter 5**.

- Display (or print) only measurements that fail, or display (or print) all measurements that pass or fail (**Output Results For**).
- Enter a title for an output heading for the displayed or printed results (**Output Heading**).
- Stop testing when a measurement fails or continue through all of the tests without stopping (**If Unit-Under-Test-Fails**).
- Pause between each measurement, or run through entire test (**Test Procedure Run Mode**).
- Start the program automatically when the Test System is powered on. (**Autostart Test Procedure on Power-up**)

Test Execution Conditions is accessed from the **SETUP TEST SET:** list. To change a default setting, position the cursor to the desired field. Pressing the knob ("selecting") will toggle the underlined selection.

Test Execution Conditions settings are not retained after a power-down/power-up cycle, and will return to their default settings.

How to Change Test Execution Conditions

1 Press **TESTS** to display the **TESTS (Main Menu)** screen.

If you are in IBASIC, press SHIFT, CANCEL before pressing TESTS.

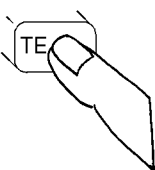

2 Position cursor at **Exec Execution Cond** and select it.

Position	Exec Execution Cond
	Cnfg External Devices
	Print Printer Setup
Select	IBASIC IBASIC Cntrl

3

Select Printer to output test procedure results to the CRT and a printer.

Select Failures to display only the CRT and printer measurements that fail.

Select Stop to stop a Test Procedure when a failure occurs.

Select Single Step to stop a Test Procedure at the end of each measurement.

TESTS (Execution Conditions)

Output Results To: Crt/Printer	1 Run Test
Output Results For: All/Failures	2 Continue
Output Heading: [REDACTED]	4 Help
	5 Main Menu
If Unit-Under-Test Fails: Continue/Stop	To Screen
Test Procedure Run Mode: Continuous/Single Step	RF GEN
Autostart Test Procedure on Power-Up: Off/On	RF ANL
	RF ANL
	SCOPE
	SPEC ANL
	ENCODER
	DECODER
	RADIO INT
	More

TESTEXEa

Chapter 2
 Using the Software with FW
 Rev. Above A.14.00

Printing and Saving Test Results

Printing and saving test results are features of the software which require additional equipment and configuration. See "**Printing**" on page 225 in **chapter 5** for detailed descriptions and instructions for these features.

**Using the Software/HP 8920A FW Rev
Below A.14.00**

NOTE:

The firmware revision A.14.00 in the HP 8920A,D had several enhancements, which are standard in the HP 8920B. This chapter applies to users with:

- **HP 8920A test sets with firmware revision below A.14.00**

The test set's firmware revision is displayed on the top right corner of the configuration screen.

- Press SHIFT CONFIG to display the configuration screen and read the firmware revision.

If you have an HP 8920B or an HP 8920A with firmware revision above A.14.00, refer to [chapter 2, "Using the Software/HP 8920B, or HP 8920A FW Above Rev. A.14.00"](#). Contact Hewlett-Packard at 1-800-922-8920 for details on upgrading your firmware if desired.

The HP 11807A software can be run on the factory default settings or customized to your individual needs and the specific requirements. This chapter provides detailed information on how to load, run, and customize the software.

Testing Overview

Pressing TESTS will display what is called the TESTS screen. To begin testing, you must first load the software and make connections. From this screen you have the option to:

Begin running tests:

- The factory default settings are acceptable for your application or
- The software has already been customized and saved to a memory card

Customize the software:

- Decide which tests you desire to run (**Edit Seqn**)
 - you may want to run all, some, or just one of the tests.
- Specify which channels to test (**Edit Freq**)
 - you may want to test one, some, or all of the channels on your radio.
- Change the pass/fail limits for specific measurements (**Edit Spec**)
 - you may want the pass/fail limits to have tighter or looser specifications than the default settings.
- Change the test environment and conditions (**Edit Parm**)
 - decide output format.
 - enter specific information about radio equipment and/or environment.
- Save any or all of the above customized changes to a memory card (**Proc Mngr**)

Set Up Test Set:

- Print test results or certain screens.
- Decide when and where test results are displayed (**Edit Cnfg**)

To Run Tests

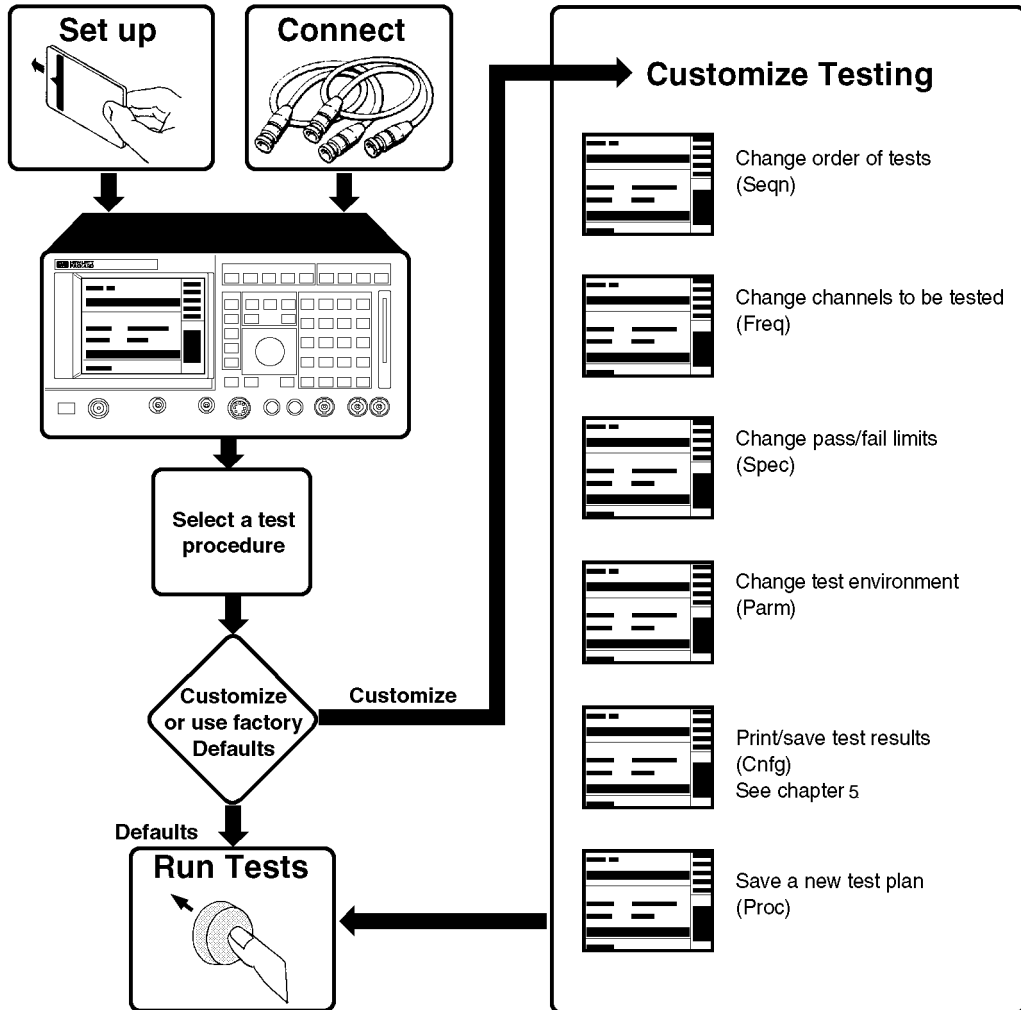

OVIEWS8

Setting Up the Test Set and Making Connections

Before you begin testing, you must set up the test set and make the appropriate hardware connections.

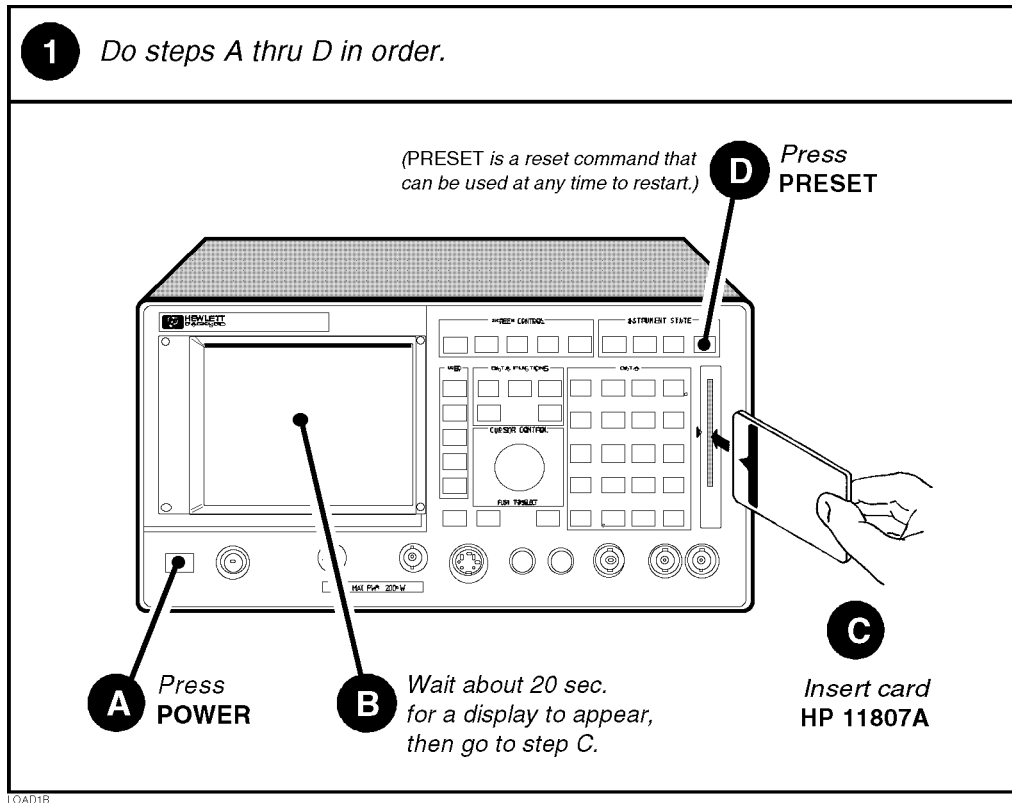

LOAD18

Making a Connection

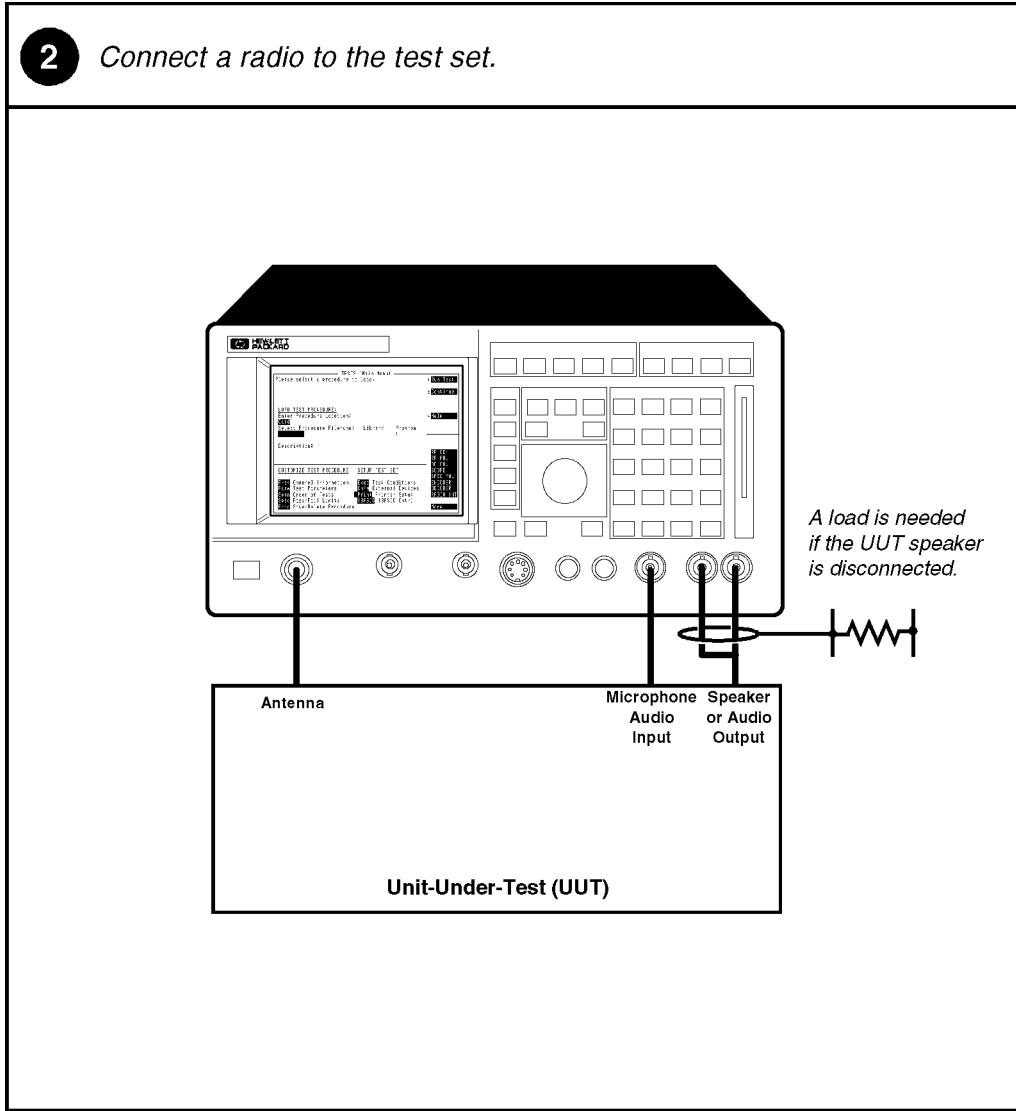

Selecting a Test Procedure









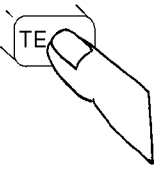

To load the software, you must first select the location to load from (in this case, it will be **Card**) and a procedure filename. Your card comes pre-programmed with at least one procedure. The actual software program does not get loaded into the test set's memory until k1 (**Run Test**) is selected. It will take approximately 2 minutes to load the software in an HP 8920A,D.

The software memory card can be removed after the program is loaded into the test set's memory. The program will remain in memory after a power-down/power-up cycle, unless it is manually deleted or a new program is loaded.

When tests begin to run, they are executed in the order in which they were entered into the Test Procedure.

Pressing CANCEL will pause the current test (press k2 to continue the test.)

Selecting A Test Procedure

<p>1 Press TESTS to display the TESTS screen.</p>	<p>2 Position cursor at Location and select it.</p>
<p>If you are in IBASIC, press SHIFT, CANCEL before pressing TESTS.</p> 	<p>Position</p>  <p>Procedure: Location</p> 
<p>3 Position cursor at Card and select it.</p>	<p>4 Position cursor at Procedure and select it.</p>
<p>Position</p>  <p>Select</p>  <p>Choices :</p> <ul style="list-style-type: none"> ■ Card ROM RAM Disk 	<p>Position</p>  <p>Procedure: Location</p>  <p>■ : Card</p>
<p>5 Position cursor at the desired Procedure and select it.</p>	<p>6 Position cursor at Run Test and select it.</p>
<p>Position</p>  <p>Select</p>  <p>Choices :</p> <ul style="list-style-type: none"> ■ XXXXXX YYYYYY ZZZZZZ 	<p>Position</p>  <p>Select</p>  <p>Procedures may take 2-3 minutes to load.</p> <ul style="list-style-type: none"> ■ Run Test 2 Continue 3 Edit Seqn 4 Edit Freq 5 Edit Spec

PROCEED1B

Customizing Testing

Because of the diversity of individual testing needs, the software has been designed so that changes may be easily made from the test set's front panel. You may store these changes on an SRAM card so that you may skip these steps in the future. See "[Saving a Test Procedure Using the Procedure Manager](#)" on page 82.

You may customize your software at any time. Because your needs change, the software allows changes to its default settings when you need to make them and in any order that you choose. For example, tests may be inserted or deleted, and later after running the tests you can change the pass/fail limits or decide to test different channels.

Most testing customization is accomplished through the test set's Test Function screens. These Test Function screens are accessed from the main TESTS screen as shown in the following figure. All Test Functions are explained in this chapter by function.

NOTE: Edit Cnfg and IBASIC will not be explained in this customizing section.

- Edit Cnfg is used when setting up printers and external disk drives which is explained in *Disks and Printing* in chapter 4.
- IBASIC is used when writing your own programs and is not explained in this manual. If you need to write your own IBASIC programs you may acquire the following manuals:
 - HP 8920A,D
 - *HP Instrument Basic User's Handbook* HP part number E2083-90000.
 - *HP 8920A Programming Manual* HP part number 08920-90220.
 - HP 8920B
 - *HP Instrument Basic User's Handbook Version 2.0* HP part number E2083-90005.
 - *HP 8920B Programming Manual* HP part number 08920-90222.

Beginning Software Customization

All software customization begins by accessing the TESTS screen first and then selecting the **Test Function** which will open the **Choices** menu. To access the TESTS screen, press TESTS on the front panel of the test set.

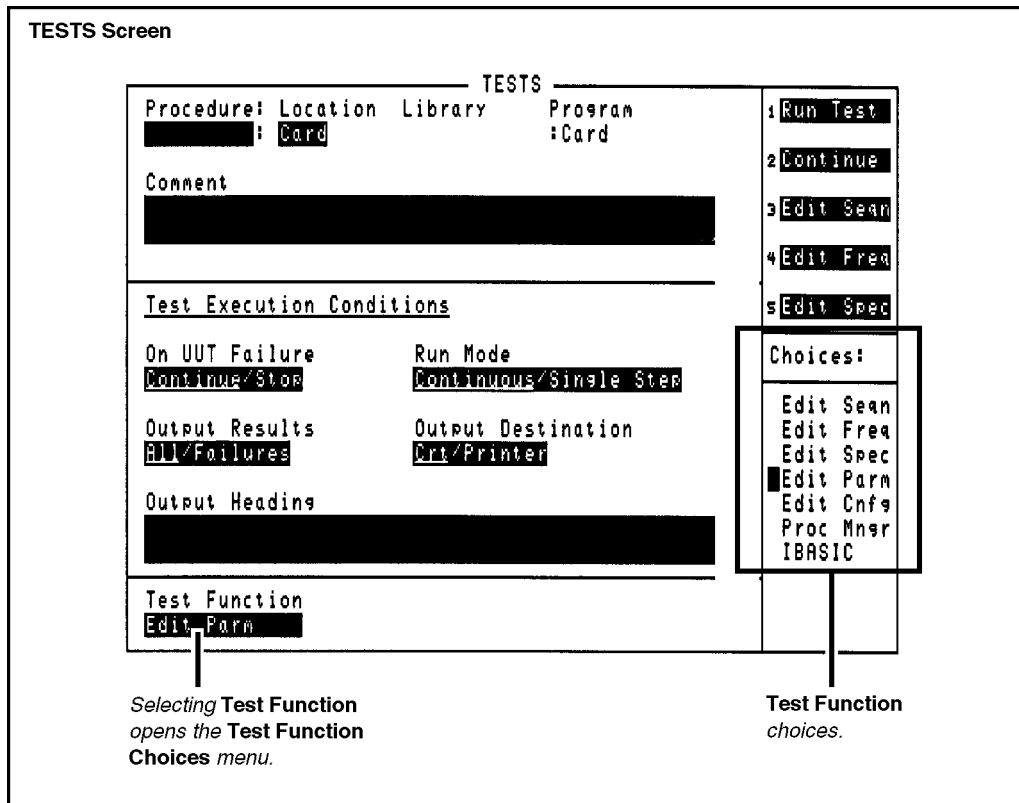

CUSTOM18

Changing the Order of Tests (Edit Sequence)







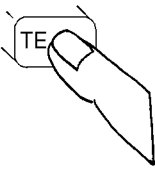

You may define a test sequence to include all, some, or just one of the tests available. When the first test is finished, the next will run. The test sequence will remain in the Test System's battery backed-up memory until another test sequence is loaded or set up. For information on saving a customized test sequence, see "[Saving a Test Procedure Using the Procedure Manager](#)" on page 82.

Creation of a test sequence is accomplished by inserting or deleting tests from the list of tests that come with the HP 11807A software package. See [chapter 4, "Test, Parameter, and Pass/Fail Limit Descriptions,"](#) on page 89, for test descriptions.

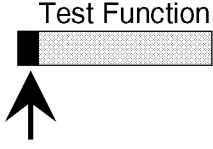
The **All Chans?** field allows the user to decide to run the test on all channels entered in the frequency table, or just the channels which are labeled **Prime**. This feature allows the user the flexibility to test **Prime** channels on all the tests in the sequence, and non-prime channels on a subset of tests (those with a **Yes** response in **All Chans**). For more information, see "[Specifying Channel Information \(Edit Frequency\)](#)" on page 72.

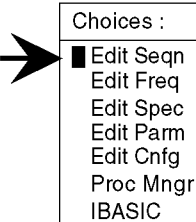

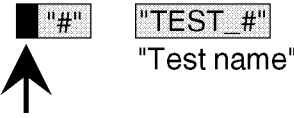

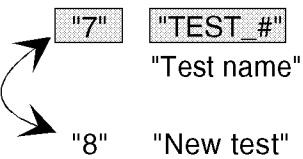



The following describes how to create a new test sequence and enter a response to **All Chans**.

How to Change a Sequence of Tests

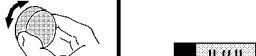
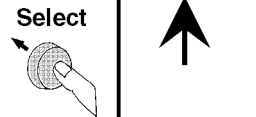
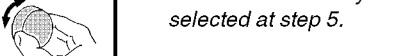
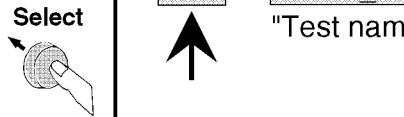
<p>1 Press TESTS to display the TESTS screen.</p>	<p>2 Position cursor at Test Function and select it.</p>
<p>If you are in IBASIC, press SHIFT, CANCEL before pressing TESTS.</p> 	<p>Position</p>  <p>Select</p>  
<p>3 Position cursor at Edit Seqn and select it.</p>	<p>4 Position cursor at Step # field and select it.</p>
<p>Position</p>  <p>Select</p>  	<p>Position</p>  <p>Select</p>  <p><i>Example</i></p> 
<p>5 By rotating knob, highlight the Step # which precedes the insertion point of the new test that you are adding, then select it.</p>	
<p>Rotate</p>  <p>Select</p> 	<p><i>For example, select step 7 if you want to insert the new test as step 8.</i></p> 

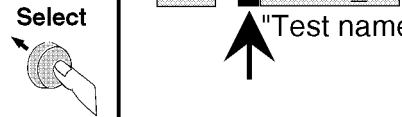
SEQ1B

Continue on next page

<p>6 Position cursor at Insrt Stp and select it.</p>	<p>7 Position cursor back at Step # field and select it.</p>
<p>Position</p>  <p>Select</p> 	<p>Position</p>  <p>Select</p> 
<p>8 Highlight Step # of the newly inserted test, then select it.</p>	<p>9 Position cursor at Test name field and select it.</p>
<p>Position</p>  <p>Select</p>  <p><i>This is the test that you selected at step 5.</i></p>	<p>Position</p>  <p>Select</p> 
<p>10 Rotate knob until desired Test Name appears, then select it</p>	<p>11 Position cursor at All Chans? field and select Yes or No.</p>
<p>Rotate</p>  <p>Select</p> 	<p>Position</p>  <p>Select</p>  <p><i>(Press the knob to change the selection.)</i></p>

5E02B

Continue on next page

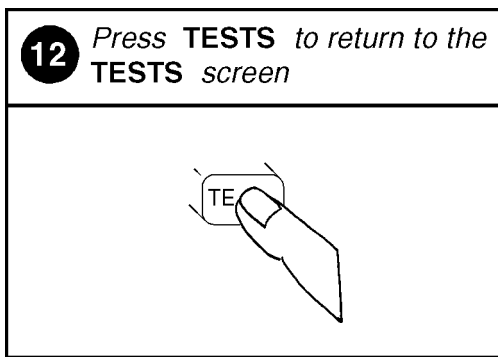

SE038

Specifying Channel Information (Edit Frequency)

For each channel that you wish to specify, you must enter the following information into the Edit Frequency screen:

- RX Chan Info
 - Enter the channel number of the voice channel to be tested.

NOTE:

Enter a **-1** in the RX or TX test frequency fields to have all subsequent frequencies ignored when testing is started.

- **Test?** (yes/no) specifies whether you want to test the UUT at this channel/frequency. If set to "No" then channel/frequency will not be tested, but you may retain the channel information in the table for later use. If set to "Yes" then the channel/frequency will be tested as defined by settings of **Prime?** and **All Chans?** fields.
- **Prime?** (yes/no) specifies which tests to perform on the channel. Select "Yes" if you want to test this channel on all the tests in the procedure. Select **No** if you want to test this channel on just a subset of tests, which are designated by selecting **Yes** in the **All Chans?** field of the Edit Seqn screen. See **All Chans?** in "[Changing the Order of Tests \(Edit Sequence\)](#)" on page 68 for more information.

For information on saving the frequency table, see "[Saving a Test Procedure Using the Procedure Manager](#)" on page 82.

The **All Chans?** field in the **Order of Tests** screen interacts closely with the **Prime?** field on the Channel Information screen. When the software runs, it begins by retrieving the first channel entered into the Channel Information screen. It then checks the response in the **Test?** field to determine if that channel should be tested at this time. If there is a **No** response in the **Test?** field, the software will go to the next channel in the table. If there is a **Yes** response in the **Test?** field, the software will check if the channel is **Prime**; there is a **Yes** response in the **Prime?** field indicating to test the channel on the entire sequence of tests in the procedure. If the channel is not prime, there is a **No** response in the **Prime?** field, the channel will be tested on a subset of tests in the procedure. The subset of tests is determined by a **Yes** response in the **All Chans?** field. Therefore, tests with a **No** response in the **All Chans?** field will be run on *prime* channels only.

Below is an example of how the software would run if you had a procedure set up as follows:

Table 1

Chan #	Test?	Prime?
Chan 01	Yes	Yes
Chan 02	Yes	No
Chan 03	No	No

Table 2

Test Number	All Chan? Setting
Test 01	No
Test 02	Yes
Test 03	Yes
Test 04	No









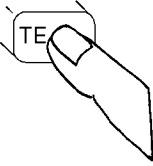

The result would be:

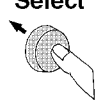
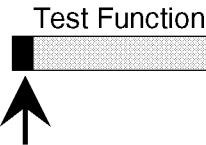
- Chan 01 runs on Test 01, Test 02, Test 03, and Test 04
- Chan 02 runs on Test 02, and Test 03 only
- Chan 03 is not tested

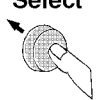
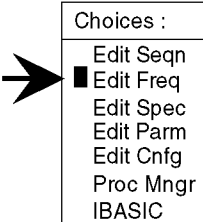
The following table shows how to properly configure these settings according to your testing needs.

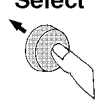
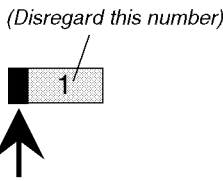

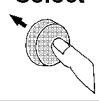
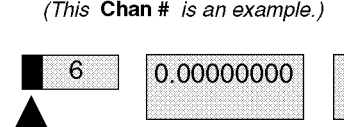

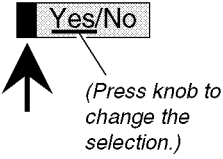



Testing Need	Necessary Field Settings		
	Test?	Prime?	All Chan?
Test channel on all tests in sequence	Yes	Yes	Don't Care
Test channel on a subset of tests in sequence	Yes	No	Yes on tests you want included in the testing subset
Do not test this channel now, but retain information for later use	No	Don't Care	Don't Care

How to Specify Channel Information

<p>1 Press TESTS to display the TESTS screen.</p>	<p>2 Position cursor at Test Function and select it.</p>
<p><i>IF you're in IBASIC, press SHIFT, CANCEL before pressing TESTS.</i></p> 	<p>Position</p>  <p>Select</p>  
<p>3 Position cursor at Edit Freq and select it.</p>	<p>4 Position cursor at Chan # field and select it.</p>
<p>Position</p>  <p>Select</p>  	<p>Position</p>  <p>Select</p>  
<p>5 Scroll to the desired Chan # and select it.</p>	<p>6 Position cursor at Test? field and select Yes or No.</p>
<p>Position</p>  <p>Select</p>  	<p>Position</p>  <p>Select</p>  

FREQ1B

Continue on next page

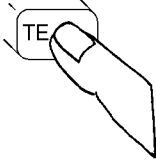
<p>7 Position cursor at Prime? field and select Yes or No.</p>	<p>8 Position cursor at RX Chan Info field and select it.</p>
<p>Position</p>  <p>Select</p>  <p>Yes/No</p>  <p>(Press knob to change the selection.)</p>	<p>Position</p>  <p>Select</p>  <p>6 0.000000</p> 
<p>9 Use DATA keys to enter new Channel #., then select it.</p> <p>Position</p>  <p>Select</p>  <p>6 0.000000 "New Info"</p> <p>(Enter Channel #)</p>	<p>10 Press TESTS to return to the TESTS screen.</p> 







FREQ2b

Changing Pass/Fail Limits (Edit Specifications)

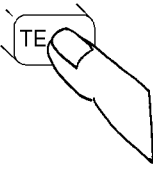
Specifications are values that set pass/fail limits for tests. Default values are available in the test software. These default values may be changed to suit your particular requirements.

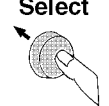
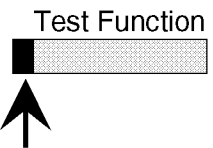

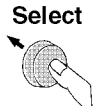

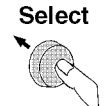
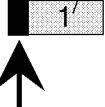



The following describes how to change the pass/fail (upper and lower) limits in the HP 8920A,D Edit Specification screen. See "[Pass/Fail Limit Descriptions](#)" on [page 162](#) in [chapter 4](#) for descriptions for each specification. For information on saving customized specifications, see "[Saving a Test Procedure Using the Procedure Manager](#)" on [page 82](#).

How to Change Pass/Fail Limits

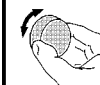
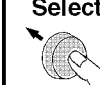
<p>1 Press TESTS to display the TESTS screen.</p>	<p>2 Position cursor at Test Function and select it.</p>
<p><i>IF you are in IBASIC, press SHIFT, CANCEL before pressing TESTS.</i></p> 	<p>Position</p>  <p>Select</p>  
<p>3 Position cursor at Edit Spec and select it.</p>	<p>4 Position cursor at Spec # field and select it.</p>
<p>Position</p>  <p>Select</p>  <div style="border: 1px solid black; padding: 5px; margin-left: 100px;"> <p>Choices :</p> <ul style="list-style-type: none"> Edit Seqn Edit Freq █ Edit Spec Edit Parm Edit Cnfg Proc Mngr IBASIC </div>	<p>Position</p>  <p>Select</p>  <p>(Disregard this number.)</p> 

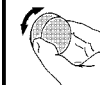
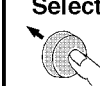



SPEC1B

Continue on next page

<p>5 Scroll to the desired Spec # and select it.</p>	<p>6 Position cursor at Lower limit field and select it.</p>
<p>Position</p>  <p>(This Spec # is an example.)</p> <p>Select</p>  <p>6 FCC TX output p -1.000000 1.</p>	<p>Position</p>  <p>6 FCC TX output p -1.000000 1.</p> <p>Select</p> 
<p>7 Use DATA keys to enter new value, then select it.</p>	<p>8 Position cursor at Upper Limit field and select it.</p>
<p>Position</p>  <p>6 FCC TX output p -0.500000 1.</p> <p>Select</p>  <p>(Enter your desired value.)</p>	<p>Position</p>  <p>C TX output power adjustme .500000 1.000000 dB</p> <p>Select</p> 
<p>9 Use DATA keys to enter new value, then select it.</p>	<p>10 Position cursor at Check field and select it.</p>
<p>Position</p>  <p>C TX output power adjustme 500000 0.500000 dB</p> <p>Select</p>  <p>(Enter your desired value.)</p>	<p>Position</p>  <p>Both</p> <p>Select</p> 

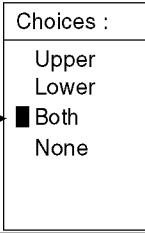
SPEC2B

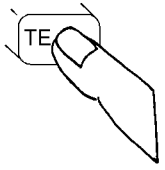
Continue on next page

11 Position cursor at Both and select it.	
Position 	
Select 	
12 Press TESTS to return to the TESTS screen.	
Position 	
Select 	







SPEC3B

Changing the Test Environment and Conditions (Edit Parameters)

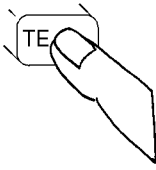
The software uses parameters to optimize the test environment and conditions for your testing situation. Many of the parameters are determined by examining your test needs. Other parameters are determined by performing measurements to calibrate items in your system. Examples of parameters include cable losses, rated system deviation, and the audio test tone frequency your system requires. The HP 11807A software comes with default settings for parameters. The defaults should be reviewed for your particular needs. See "[Test Parameter Descriptions](#)" on page 127 in [chapter 4](#) for descriptions and default values for each parameter. For information on saving customized parameters, see "[Saving a Test Procedure Using the Procedure Manager](#)" on page 82.

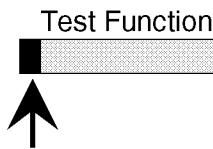
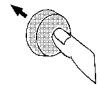

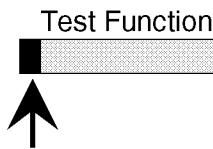
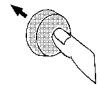

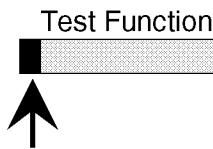
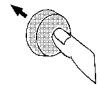





The following describes how you can change parameters through the Edit Parameter screen to optimize your testing conditions.

How to Change the Test Environment and Conditions

1 Press TESTS to display the TESTS screen.	2 Position cursor at Test Function and select it.				
<p>If you are in IBASIC, press SHIFT, CANCEL before pressing TESTS.</p> 	<table border="1"><tr><td data-bbox="794 1100 917 1207">Position </td><td data-bbox="922 1100 1274 1207">Test Function </td></tr><tr><td data-bbox="794 1213 917 1333">Select </td><td data-bbox="922 1213 1274 1333"></td></tr></table>	Position 	Test Function 	Select 	
Position 	Test Function 				
Select 					

PARM1B

Continue on next page

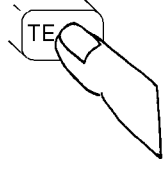
<p>3 Position cursor at Edit Parm and select it.</p>	<p>4 Position cursor at Parm # field and select it.</p>
<p>Position  Select </p> <p>Choices : Edit Seqn Edit Freq Edit Spec Edit Parm Edit Cnfg Proc Mngr IBASIC</p>	<p>Position  Select </p> <p>(Entries on your display may be different.)</p> <p>1 RT audio test to 0.000000</p>
<p>5 Scroll to Parm # to be changed and select it</p>	<p>6 Position cursor at Value field and select it.</p>
<p>Scroll  Select </p> <p>(This parameter number and description are examples.)</p> <p>15 TX cable loss</p>	<p>Position  Select </p> <p>15 TX cable loss 0.000000</p>
<p>7 Use DATA keys to enter new value, and select it.</p>	<p>8 Press TESTS to return to the TESTS screen.</p>
<p>Enter  Select </p> <p>15 TX cable loss 1.000000</p> <p>(Enter your desired value.)</p>	<p>TESTS</p> 

PARM2B









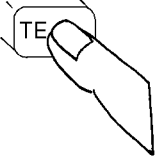

Saving a Test Procedure Using the Procedure Manager

A Test Procedure is a collection of pass/fail limits (specifications), the test environment and conditions (parameters), and a TEST sequence, saved in a file that customizes the test software to a specific application. You may save the file to a memory card or disk.

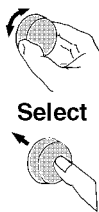
When you save a Procedure you will be saving parameters, specifications, and a test sequence, plus a library that contains the names of all parameters, specifications, and tests that are resident in the HP 11807A software. The library file comes from the HP 11807A software and cannot be modified. The library file will be automatically saved on the card or disk that is being used to store the new test procedure.

The following example shows how to save a new procedure to a memory card. For more information concerning procedures, see "[Procedures](#)" on page 240 in [chapter 5](#).

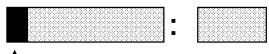
How to Save a Test Procedure

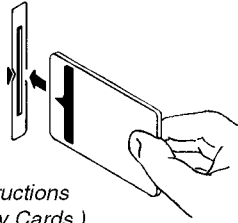
<p>1 Press TESTS to display the TESTS screen.</p>	<p>2 Position cursor at Test Function and select it.</p>
<p>If you are in IBASIC, press SHIFT, CANCEL before pressing TESTS.</p> 	<p>Position</p>  <p>Select</p>  <p>Test Function</p> 
<p>3 Position cursor at Proc Mngr and select it.</p>	<p>4 Position cursor at Procedure field and select it.</p>
<p>Position</p>  <p>Select</p>  <p>Choices :</p> <ul style="list-style-type: none"> Edit Seqn Edit Freq Edit Spec Edit Parm Edit Cnfg ■ Proc Mngr IBASIC 	<p>Position</p>  <p>Select</p>  <p>Procedure: Location</p> 
<p>5 Select characters to name the Procedure, then select Done.</p>	<p>6 Insert an initialized SRAM memory card.</p>
<p>Position</p>  <p>Select</p>  <p>Choices :</p> <ul style="list-style-type: none"> Done Position Over/Ins Delete Del End Bk space ■ A B C 	 <p>(For detailed memory card initialization instructions see chapter 5 -Memory Cards.)</p>

PROCMA1B

Continue on next page

7 Position cursor at **Location** and select it.

Procedure: Location

8 Position cursor at **Card** and select it.

Position

Select

Choices :

- Card
- RAM
- Disk

(You can also save procedures to an internal RAM disk or external disk drive. See Chapter 5-Disks.)

9 Position cursor at **Comment** and select it.

Position

Select

Comment

10 Select characters for the **Comment**, then select **Done**.

Position

Select

Choices :

- Done
- Position
- Over/Ins
- Delete
- Del End
- Bk space
- A
- B
- C

11 Position cursor at **Library for new p....**, and select **Current**.

Position

Select

Library for new procedure

Current / [NO LIB]

(The underline indicates which option is selected. Pressing knob changes the selection.)



12 Position cursor at **Program location for** and select it.

Program location for new procedure



Card

Continue on next page

13 Position cursor at **Card** and select it.

Position 		Choices : ■ Card RAM Disk
Select 		

14 Position cursor at **Action** and select **Make Procedure**.

Position 	Action ■ Make Procedure Delete Procedure
Select 	(To make selection, position the cursor in front of Make Procedure , then press the knob.)

15 Press **TESTS** to return to the **TESTS** screen.

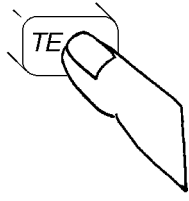

To run the saved procedure:

- 1) Load the **Procedure**.
- 2) Insert the original HP 11807A,E memory card.
- 3) Press **Run Test**.

The original card contains the full program needed to run your procedure.

PROCMA3B

Changing Test Execution Conditions

Test Execution Conditions define how your testing program starts and where and when test output occurs. You may decide to:

- Start the program automatically when the Test System is powered on. (**Autostart**)
- Stop testing when a measurement fails or continue through all of the tests without stopping. (**On UUT Failure**)
- Display (or print) only measurements that fail, or display (or print) all measurements that pass or fail. (**Output Results**)
- Pause between each measurement, or run through the entire test sequence. (**Run Mode**)
- Display output on CRT only, or display on CRT and print hardcopy. (**Output Destination**)

NOTE:

If printing test results is desired, after selecting **Printer** additional steps are necessary to connect and configure the printer. See "[Printing](#)" on page 225.

- Enter a title for an output heading for the displayed or printed results. (**Output Heading**). Select the field with the knob and enter the output heading by selecting the appropriate letters and the select **Done**.

Test Execution Conditions is located on the TESTS screen. Press TESTS to display them. To change a default setting, position the cursor to the desired field. Pressing the knob ("selecting") will toggle the underlined selection.

Test Execution Conditions settings (except for **Autostart**) are not retained after a power-down/ power-up cycle, and will return to their default settings. They are not stored on the memory card when a test procedure is saved.

How to Change Test Execution Conditions

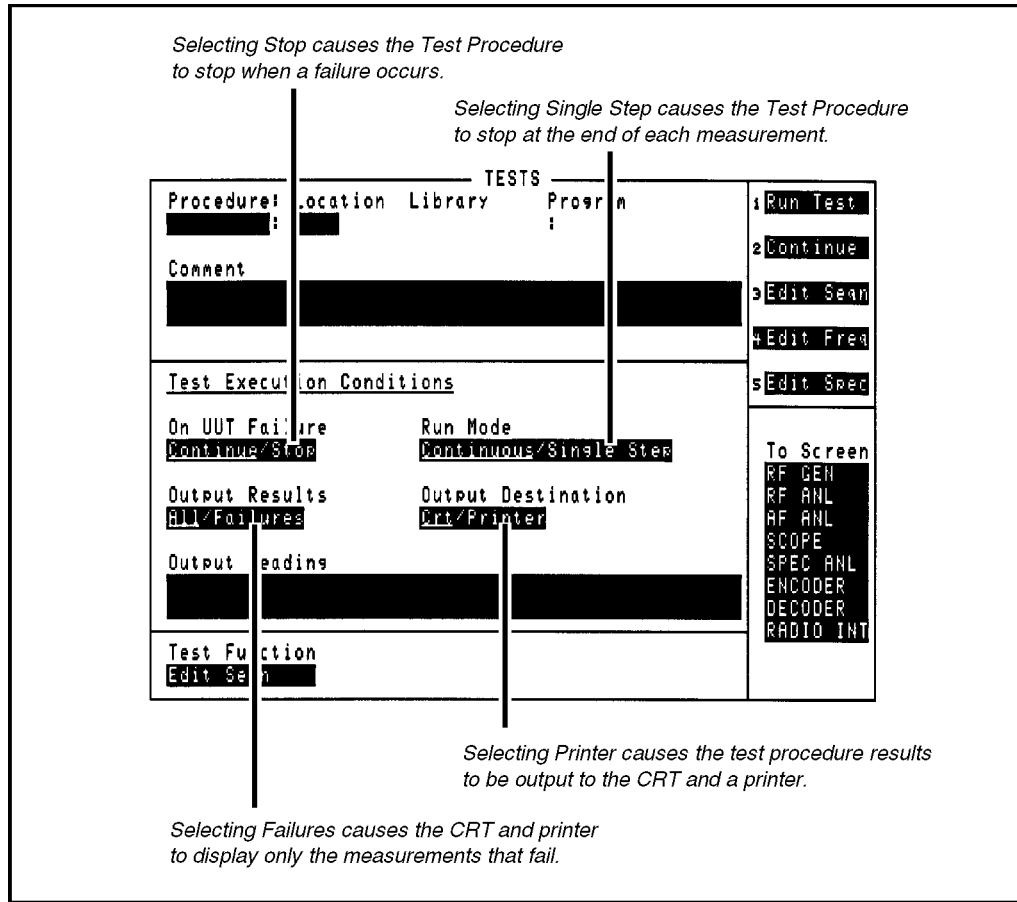

Printing and Saving Test Results

Printing and saving test results are features of the HP 11807A software which require additional equipment and configuration. See **"Printing" on page 225** in **chapter 5** for detailed descriptions and instructions for these features.

Test, Parameter, and Pass/Fail Limit Descriptions

Introduction

Tests are a series of measurements, and one or more tests make up a procedure (see [chapter 2](#) or [chapter 3](#)). While you may change the tests that make up a procedure, you may not change the measurements the test will perform. Generally, the order in which the tests are run is not important.

This chapter describes each test and the associated test parameters, pass/fail limits, and external equipment that are required. When you first load a test procedure or create a new test sequence, refer to this section to understand what test parameters and pass/fail limits are required for each test.

Tests are derived from the following industry standards:

- EIA – Electronic Industry Association, for 800MHz Cellular Subscriber Units
 - EIA/IS-19-B
 - EIA/TIA-553

NOTE:

Refer to [chapter 2, "Using the Software/HP 8920B, or HP 8920A FW Above Rev. A.14.00," on page 23](#) in this manual for details about customizing a Test Procedure for testing your FM radio.

TEST_01. CP Registration

This test reads the phone's Number Assignment Module (NAM) and outputs the following registration information:

Phone number.
Serial number.
Power class.
Transmission (continuous or discontinuous).

A registration must be performed before any tests can be run, otherwise the operator is prompted to enter the UUT phone number during testing.

The test works as follows:

- The test set transmits the Registration ID message repeatedly, with the value of the REGID field set alternately to 0 and 500. This induces the phone to register with the test set.
- If an error occurs in this test, all testing is stopped.

A CP registration test must be run at least once before any call processing tests can be run, otherwise the operator is prompted to enter the UUT phone number during testing. After CP registration is run once it does not need to be run again for the test set to be able to perform other tests. The registration data is remembered unless it is erased by loading new test software, registering a different radio, or executing a **SCRATCH C** command in IBASIC.

Pass/fail Limits Used

None

Test Parameters Used

Parameter 1. AA Enter Ph#? [0=If Needed, 1=Always, Here]
Parameter 2. AB AID Number
Parameter 4. CP Control Channel
Parameter 5. CP DSAT Vector
Parameter 6. CP Prt RECC RVC Data
Parameter 7. CP SAT Tone
Parameter 9. RT External Path Loss
Parameter 12. RT Nominal Supply Voltage
Parameter 14. RT use DUPLEX OUT & ANT IN
Parameter 22. RX RF Level for Signaling
Parameter 41. TX TS Atten for Signaling

TEST_02. CP Page

This test simulates a call to the mobile phone from the base station. Specifically, this test does the following:

1. The test set acts as a base station and pages the UUT.
2. 3 of 5 majority voting on the Reverse Control Message is performed.
3. Reverse Control Channel (RECC) information received from the UUT is printed.
4. BCH error detection and correction of the Reverse Control Message is performed.
5. Each section of the page response message is tested, bit by bit.
6. Sends an Initial-Voice-Channel-Designation order to the UUT, directing it to tune to a voice channel obtained from the **Channel Information** (or **Edit Freq**) table. If the channel number from the table has an N suffix, the phone will be directed to a narrow voice channel. If the channel number has no suffix, the phone will be directed to a wide voice channel.
7. Sends an ALERT order to the UUT by way of the Forward Voice Channel (FVC).

Test Parameters Used

Parameter 1. AA Enter Ph#? [0=If Needed, 1=Always, Here]

Parameter 2. AB AID Number

Parameter 4. CP Control Channel

Parameter 5. CP DSAT Vector

Parameter 6. CP Prt RECC RVC Data

Parameter 7. CP SAT Tone

Parameter 9. RT External Path Loss

Parameter 12. RT Nominal Supply Voltage

Parameter 14. RT use DUPLEX OUT & ANT IN

Parameter 22. RX RF Level for Signaling

Parameter 41. TX TS Atten for Signaling

TEST_03. TX Frequency Error

This test measures the difference between the unmodulated carrier frequency and the assigned carrier frequency. TX frequency error is measured on a voice channel with voice modulation off, and SAT modulation on.

The frequency error is expressed in parts-per-million (ppm).

Pass/fail Limits Used

Pass/Fail Limit 25. TX Frequency Error

Test Parameters Used

*If test **parameter 13** is set to test at extremes, then TX frequency error is measured at high, medium, and low supply voltages (only if an external power supply has been configured to be used over HP-IB by the test set):*

Parameter 10. RT High Supply Voltage

Parameter 11. RT Low Supply Voltage

Parameter 12. RT Nominal Supply Voltage

Parameter 13. RT Test at Extreme Settings

TEST_04. TX Carrier Power

This test measures the power available at the output terminals of the transmitter when connected to a 50 ohm load. This test is performed at the nominal supply voltage. If test parameter 13 is set to test at extremes, it can also be performed with high and low supply voltages for extreme measurements (if an external power supply is configured to the test set).

This test requires a programmable power supply if high-supply and low-supply power measurements are to be made.

Output power is expressed in either dBW or W, as determined by test parameter 42.

Pass/fail Limits Used

Normally, all 8 power levels are tested; however, test parameter 30 allows you to select only the levels you want tested.

- 11 TX carrier power at level 0
- 12 TX carrier power at level 1
- 13 TX carrier power at level 2
- 14 TX carrier power at level 3
- 15 TX carrier power at level 4
- 16 TX carrier power at level 5
- 17 TX carrier power at level 6
- 18 TX carrier power at level 7

See [Pass/Fail Limits 11-18. TX Carrier Power @Levels 0-7](#)

Test Parameters Used

[Parameter 6. CP Prt RECC RVC Data](#) (This test runs slower if test parameter 6 is set to print RVC data.)

[Parameter 9. RT External Path Loss](#)

[Parameter 10. RT High Supply Voltage](#)

[Parameter 11. RT Low Supply Voltage](#)

[Parameter 12. RT Nominal Supply Voltage](#)

[Parameter 13. RT Test at Extreme Settings](#)

[Parameter 14. RT use DUPLEX OUT & ANT IN](#)

[Parameter 30. TX Carrier Power Levels Tested](#)

[Parameter 41. TX TS Atten for Signaling](#)

[Parameter 42. TX Units for Power Meas](#)

Testing Conditions Fixed by the Software

- The power-level pass/fail limits for Class II and III radios are fixed by the software.

TEST_05. TX Peak Frequency Deviation

Modulation deviation limiting of the UUT transmitter is tested by performing the following steps. The PK+ detector is used during the first pass and then the steps are repeated using the PK– detector.

1. The audio generator frequency is set to 1 kHz.
2. The audio generator level is set to produce 5.7 kHz deviation by the UUT (3 kHz deviation for narrow analog operation). (Vary test parameter 43 to change the microphone input level).
3. The audio generator level is increased by 20 dB.
4. The audio generator frequency is stepped from 300 Hz to 3 kHz while the audio generator level is maintained at the 20 dB overdrive. The size of the frequency steps is obtained from test parameter 36. (If test parameter 36=0, then the test will be run at 1 kHz only.) The peak frequency deviation is measured and reported at each step.

Audio connections from the radio to the test set are required for this test.

Pass/fail Limits Used

Pass/Fail Limit 30. TX NTACS Peak Frequency Deviation

Pass/Fail Limit 31. TX Peak Frequency Deviation

Test Parameters Used

Parameter 8. RC Compandor Always On

Parameter 22. RX RF Level for Signaling

Parameter 36. TX Peak Frequency Deviation Step Frequency

Parameter 37. TX Pk Freq Dev 50 Hz HPF

Parameter 43. TX Voltage for Compressor Zero Crossing

TEST_06. TX Audio Frequency Response

This test measures how closely the frequency deviation of the transmitter follows a 6 dB/octave pre-emphasis slope over a given frequency range. (This test is intended to be used between the audio response frequencies of 300 Hz and 3 kHz only.) *Audio connections from the radio to the test set are required for this test.*

The test results indicate the flatness of the audio output as frequency is varied. The UUT's compressor is not disabled during this test.

Audio frequency response is expressed in dB error from the 6 dB/octave pre-emphasis slope.

Vary test parameter 43 to change the microphone input level.

Pass/fail Limits Used

[Pass/Fail Limit 10. TX Audio Response Dev From 6 dB/Oct](#)

Test Parameters Used

[Parameter 8. RC Compandor Always On](#)

[Parameter 22. RX RF Level for Signaling](#)

[Parameters 27-29. TX Audio Response Start, Step, and Stop Frequencies](#)

[Parameter 43. TX Voltage for Compressor Zero Crossing](#)

Testing Conditions Fixed by the Software

- Audio frequency response is measured at 2.3 kHz peak deviation for wide voice channels and 1.5 kHz peak deviation for narrow voice channels.
- The frequency response measurement is made with the RMS detector and is made with respect to a 1 kHz reference rate.

TEST_07. TX Audio Distortion

This test measures the level of the demodulated carrier's audio distortion. *Audio connections from the radio to the test set are required for this test.*

The test set does not have expander circuitry. If your testing conditions require correction for this situation, you must change the limits set in pass/fail limit 9 as required.

Transmitter audio distortion is expressed in dB.

Pass/fail Limits Used

[Pass/Fail Limit 9. TX Audio Distortion](#)

Test Parameters Used

[Parameter 8. RC Compressor Always On](#)

[Parameter 22. RX RF Level for Signaling](#)

[Parameter 35. TX De-emphasis](#)

[Parameter 43. TX Voltage for Compressor Zero Crossing](#)

Testing Conditions Fixed by the Software

- Audio distortion is measured at 2.3 kHz deviation and a 1 kHz rate.
- 1.5 kHz deviation is used for narrow voice channels.
- The measurement is made with the peak + detector and a 1 kHz notch filter.
- If present, the CCITT psophometric bandpass filter will be used. If not, the C-Message bandpass filter will be used. If not, the 300 Hz HPF and 3 kHz LPF will be used. (Because the SAT tone is only partially removed by the 3 kHz LPF, distortion readings with it may be too high).

NOTE:

The measurement method described above will usually produce results a few dB lower than measurements obtained by measuring only the level of the third harmonic of 1 kHz relative to the level of the fundamental (as specified in the TACS for Japan Standard).

TEST_08. TX Signaling Tone/DST

If the channel is a wide voice channel, this test measures the signaling tone's frequency and peak deviation. Since the SAT tone is always on in this test, deviation is measured with the RMS detector, with and without the signaling tone on. The peak deviation of the signaling tone is calculated from the two readings. Therefore, test results indicate peak deviation, not peak+ or peak-.

If the channel is a narrow voice channel, the peak deviation of the digital signaling tone (DST) is measured and the DST sequence is decoded and reported in hexadecimal.

Since this test is run in the "maintenance mode" where the base station is waiting for an answer, the operator must press the send key on the handset to exit the test.

Applications:

The signaling tone (ST) is a 10 kHz tone generated by the phone on a wide voice channel and is transmitted to the cell site for confirming orders (Alert, Audit, Change Power, etc.), and for signaling flash and release requests.

The digital signaling tone (DST) performs the same function on the narrow voice channel that ST performs on the wide voice channel. DST is a 24 bit digital sequence transmitted continuously at 200 NRZ bits/second and producing an average peak deviation of 700 Hz. Each DST sequence is the logical inverse of a corresponding DSAT sequence.

Pass/fail Limits Used

[Pass/Fail Limit 28. TX NTACS DSAT Deviation](#)
[Pass/Fail Limit 34. TX Signaling Tone Deviation](#)
[Pass/Fail Limit 35. TX Signaling Tone Frequency](#)

Test Parameters Used

[Parameter 8. RC Compandor Always On](#)
[Parameter 22. RX RF Level for Signaling](#)

TEST_09. TX FM Hum and Noise

This test measures the ratio of residual frequency modulation to the standard test modulation. *Audio connections from the radio to the test set are required for this test.*

The test set does not have expander circuitry. If your testing conditions require correction for this situation, you must change the limits set in pass/fail limit 24 as required.

FM hum and noise is expressed in dB, from the formula:

$$-20 \times \text{Log}(\text{Reference Deviation} \div \text{Present Deviation})$$

Pass/fail Limits Used

[Pass/Fail Limit 24. TX FM Hum and Noise](#)

Test Parameters Used

[Parameter 8. RC Compandor Always On](#)

[Parameter 22. RX RF Level for Signaling](#)

[Parameter 35. TX De-emphasis](#)

[Parameter 43. TX Voltage for Compressor Zero Crossing](#)

Testing Conditions Fixed by the Software

- TX FM hum and noise is measured from a reference taken at 2.3 kHz deviation at a 1 kHz rate with a SAT tone present.
- For narrow analog operation, the reference is taken at 1.5 kHz deviation with DSAT active.
- The SAT tone or DSAT is present throughout this measurement.
- The AF Analyzer CCITT or C-Message filter is enabled (if present), the detector is changed to RMS, and a 0 dB reference is set.
- The 1 kHz modulation is turned off, and the TX FM hum and noise is measured.
- The phone's microphone must be muted for best results.

TEST_10. TX SAT/DSAT

If the channel is a wide voice channel, this test measures the frequency error and peak deviation of the three SAT tones. The rms detector is used for measuring SAT tone deviation and the reading is converted to peak.

Also, this test uses the 6 kHz BPF option if it is installed. (If there is no filter and the UUT has an open microphone, the readings may be affected by background noise. In this case, mute the handset.)

If the channel is a narrow voice channel, the test set transmits DSAT sequence #3=25AD4D in hexadecimal. The peak deviation of the DSAT returned by the phone is measured and reported. An eye-pattern test is performed on the DSAT and the closure and phase jitter are measured and reported.

Applications:

The supervisory audio tones (SAT) are 5970, 6000, and 6030 Hz tones used for signaling. One of the three tones is added to the wide channel voice transmission by a cell site. The radio then detects the tone and modulates the transmitted voice-channel carrier with a constant (relative) phase tone which is regenerated from the received tone to establish a closed loop between the mobile (cellular radio) and the cell site.

Transmission of the SAT is suspended during transmission of wideband data on the reverse voice channel (RVC), but is not suspended when the signaling tone (ST) is sent.

The digital supervisory tone (DSAT) performs the same function on the narrow voice channel that SAT performs on the wide voice channel. DSAT is a 24 bit digital sequence transmitted continuously at 200 NRZ bits/second and producing an average peak deviation of 700 Hz. Seven different sequences are defined.

NOTE: The phone's microphone must be muted for best results.

Pass/fail Limits Used

- Pass/Fail Limit 27. TX NTACS DSAT Closure
- Pass/Fail Limit 28. TX NTACS DSAT Deviation
- Pass/Fail Limit 29. TX NTACS DSAT Phase Jitter
- Pass/Fail Limit 32. TX SAT Deviation
- Pass/Fail Limit 33. TX SAT Frequency Error

Test Parameters Used

Parameter 5. CP DSAT Vector

Parameter 8. RC Compandor Always On

Parameter 22. RX RF Level for Signaling

TEST_11. TX RVC Data Deviation

This test provides three possible modes of operation, determined by parameter 44 *TXT transient/ss data* [0=tran 1=bth 2=ss].

The first method, selected by setting parameter 44 to 0=tran, measures the Peak+ and Peak- frequency deviation of the data in the entire Reverse Voice Channel (RVC) burst to ensure that it is within the specified limits.

The entire burst is tested by sending the FVC message 5 times while the peak+ hold detector is on, and another 5 times while the peak- hold detector is on.

The second method, selected by setting parameter 44 to 1=bth, first performs the test on just the steady state portion of the RVC data signal, followed by a test of the entire signal (described above).

The steady state portion of the test is performed by measuring the RVC data signal between 20 msec and 50 msec following the beginning of the data burst. The peak + and - results are compared to values in pass/fail limit 36 *TX wideband data deviation*. The results of the transient portion of the test are compared to values in the pass/fail limit 37 *TXT wideband data deviation transient*.

The third method, selected by setting parameter 44 to 2=ss, performs the test on just the steady state portion of the RVC data signal (as described above).

NOTE:

In all three methods, the UUT should blank the SAT tone before sending the RVC message; therefore, SAT deviation should not be included in the deviation measurement. If the UUT has an open microphone, the readings may be affected by background noise. In this case, mute the handset.

The second and third test methods use trigger delay capabilities and can only be performed on an HP 8920B. If you are using an HP 8920A with HP 11807A, the software will ignore the setting of parameter 44 and perform the test using the first method only.

Using the first method, Hewlett-Packard Company has found that some cellular telephones fail this test because the telephones produce a carrier frequency transient at the beginning of wideband data transmission. This causes the peak frequency deviation to exceed the maximum pass/fail limit of $\pm 6.4 \text{ kHz} \pm 10\%$ (or a total of $\pm 7.04 \text{ kHz}$) specified in the TACS for Japan Standard. This transient typically occurs during the first 10 milliseconds of the wideband data transmission from the telephone. The HP 11807A Option 007 software measures the FM peak deviation during the entire period while the telephone transmits its data and holds and displays only the highest positive and negative peaks detected. The HP Test Set has a fast peak detector which captures the peak deviation that occurs over the entire period, including the deviation that occurs in the first 10 milliseconds. The measurement method conforms to the TACS for Japan Standard.

Applications:

RVC data is Manchester-encoded data that is used for cellular system signaling and control. Manchester encoding is accomplished by transforming each NRZ (non-return to zero) binary one to a zero-to-one transition and each NRZ binary zero to a one-to-zero transition. The data stream is then used to modulate the transmitter carrier using direct, binary, frequency-shift keying (FSK).

On the wide voice channels, the data rate is 8 kilobits/second and the nominal peak transmitted deviation is 6.4 kHz. All other modulation sources to the transmitter are inhibited when the data is transmitted ("blank and burst").

On the narrow voice channels, the data rate is 100 bits/second and the nominal peak transmitter deviation is 700 Hz. The data words are inserted into the DSAT data stream. The transmitter is modulated simultaneously by voice audio and the data stream.

Pass/fail Limits Used

Pass/Fail Limit 28. TX NTACS DSAT Deviation
Pass/Fail Limit 36. TX Wideband Data Deviation
Pass/Fail Limit 37. TXT Wideband Data Deviation Transient

Test Parameters Used

Parameter 8. RC Compandor Always On
Parameter 22. RX RF Level for Signaling
Parameter 44. TXT Trnsient/SS Data [0=tran 1=bth 2=ss]

TEST_12. TX Compressor Response

This test measures the compressor's zero reference deviation and operating range. For every 2 dB change in input level, there should be a nominal output level change of 1 dB. *Audio connections from the radio to the test set are required for this test.*

Compressor response is expressed in kHz for the zero reference deviation, and in dB of tracking error over the indicated operating range.

Applications:

A compressor is used in the phone's voice input circuitry to decrease the variability of the modulation due to volume changes from the talker. In combination with an expander in the cell site receiver, this provides improved signal-to-noise-ratio in the demodulated audio.

Pass/fail Limits Used

Pass/Fail Limit 19. TX Compressor Track Error dB

Pass/Fail Limit 20. TX Compressor Zero Reference Deviation

Pass/Fail Limit 26. TX NTACS Compressor Zero Reference Deviation

Test Parameters Used

Parameter 8. RC Compandor Always On

Parameter 22. RX RF Level for Signaling

Parameters 31-33. TX Compressor Start, Step, and Stop Levels

Parameter 43. TX Voltage for Compressor Zero Crossing

Testing Conditions Fixed by the Software

- Compressor response to different input levels is measured.
- The "zero crossing" deviation is first measured by applying a 1 kHz-rate input voltage to the UUT at a level specified by test parameter 43.
- The deviation is next set to 2.3 kHz (1.5 kHz for narrow analog) and a reference is taken with the rms detector.
- The input is then varied using the start, stop and step parameters 31-33 and the rms deviation is measured and the compressor response relative to the reference is calculated.

TEST_13. TX Current Drain

This test measures the average power supply current drawn by the UUT when it is operating. The transmitter's current drain is expressed in amps. This test can measure current drain using two methods. The test software first looks to see if an HP-IB power supply has been configured in the External Devices (or Edit Cnfg) screen. If one has been configured, the current drain will be measured via the programmable power supply over HP-IB; see the procedure for "[Configuring an HP-IB Power Supply](#)" on page 108. If an HP-IB power supply is not available, (HP-IB power supply not configured in External Devices (or Edit Cnfg) screen), the software measures current drain through the rear-panel dc current measurement capability of the test set; see the procedure "[Configuring the Rear-Panel dc-Current Measurement](#)" on page 108.

This test is not specified by radio test standards.

A Hewlett-Packard programmable dc power supply is required for this test if an HP-IB power supply is to be configured. A power supply with sufficient voltage and current capabilities from the following series must be used (which uses SCPI commands):

- HP 664xA
- HP 665xA
- HP 667xA
- HP 668xA

Configuring an HP-IB Power Supply

The following must be done to setup the power supply through the HP-IB on the test set:

1. Connect the power supply's HP-IB interface to the test set's HP-IB interface with an appropriate length HP-IB cable.
2. Press TESTS on the front panel.
3. Select **External Devices** from the **SET UP TEST SET** list (or **Edit Cnfg** from the **Test Function** field).
4. Position the cursor to the **Inst#** field and select it.
5. Rotate knob until an empty **Calling Name** field appears, and select it.
6. Using the list of characters in the **Choices** menu, enter the words **Power Supply** in the **Calling Name** field. Select **Done** when complete.
7. Position the cursor to the **Model** field and select it (optional).
8. Using the DATA keypad and list of characters in the **Choices** menu, enter the Model # and press ENTER.
9. Position the cursor to the **Addr** (address) field and select it.
10. Using the DATA keypad, enter **7XX** (X = 1 through 30) for the HP-IB address and press ENTER.
11. From the **To Screen** menu, select **More**.
12. From the **Choices** menu, select **IO CONFIG**.
13. Position the cursor to the **Mode** field and select it.
14. From the **Choices** menu, select **Control**.
15. Press TESTS to return to TESTS screen. The power supply is now ready to be controlled by the test set when the current drain test is run.

Configuring the Rear-Panel dc-Current Measurement

1. The dc-current measurement must be zeroed before the measurement. Access the test set's TESTS screen by pushing the TESTS key on the front panel.
2. Position the cursor to the **AF ANL** field under **To Screen** and select it.
3. Position the cursor to the **dc Current** field and select it (this should be done before any current is applied to the test set's measurement terminals). The dc-current measurement is now zeroed.
4. Use a dc power supply that provides the appropriate voltage and current for your UUT.
5. Connect the positive lead of the power supply to the positive terminal (banana) of the dc-current measurement connector on the lower-left rear panel of the test set.
6. Connect the negative terminal (banana) of the dc-current measurement connector to the positive terminal of the mobile unit's supply input.
7. Connect the negative terminal of the power supply directly to the negative terminal of the mobile unit's supply input.
8. The software will automatically measure the current passing through the rear-panel connection. Be sure that there is no HP-IB power supply configured in the External Devices (or Edit Cnfg) screen of the test set, see the procedure above for "[Configuring an HP-IB Power Supply](#)" on page 108.

Pass/fail Limits Used

Normally, all 8 current-drain levels are tested; however, test parameter 34 allows you to select only the levels you want.

Pass/Fail Limit 21. TX Current Drain @Levels 0-3
Pass/Fail Limit 22. TX Current Drain @ Levels 4-7

Test Parameters Used

Parameter 6. CP Prt RECC RVC Data
Parameter 34. TX Current Drain Levels Tested
Parameter 41. TX TS Atten for Signaling

Testing Conditions Fixed by the Software

- Only SAT modulation is on during the test.

TEST_14. RX Expander

This test measures the expander's zero reference level and operating range. For every 1 dB change in input level, there should be a nominal output level change of 2 dB. *Audio connections from the radio to the test set are required for this test.*

Expander response is expressed in dBV for the zero reference level, and in dB for the tracking error over the indicated operating range.

Applications:

An expander is used to provide the complement of the compressor in the cell site transmitter. Together, the compressor and expander provide improved signal-to-noise-ratio in the demodulated audio.

Pass/fail Limits Used

Pass/Fail Limit 3. RX Expander Track Error
Pass/Fail Limit 4. RX Expander Zero Reference Level
Pass/Fail Limit 6. RX NTACS Expander Zero Reference Level

Test Parameters Used

Parameter 8. RC Compandor Always On
Parameters 18-20. RX Expander Start, Step, and Stop Levels
Parameter 25. RX Set Audio Level
Parameter 26. RX Tolerance for Setting Audio Level

Testing Conditions Fixed by the Software

- The expander response is measured at a 1 kHz rate and an RF input level of -50 dBm.
- If present, the CCITT psophometric bandpass filter will be used. If not, the C-Message bandpass filter will be used. If not, the 300 Hz HPF and 3 kHz LPF will be used.
- A 2.3 kHz (1.5 kHz for narrow analog operation) deviation is applied and the "zero crossing" of the receiver is measured. This value is retained as the reference level.
- Deviation is then varied over the desired range and the expander response relative to the "zero crossing" point is calculated.
- The sweep levels are set by the parameters listed above.

TEST_15. RX Audio Frequency Response

This test measures the ability of the receiver's audio output circuitry to follow a 6 dB/octave de-emphasis curve, as well as to follow an audio-bandpass response. The RF level for signaling (test parameter 22) is applied with a constant deviation. The modulation rate is swept over the audio frequency-response range (determined by test parameters 15-17).

Audio connections from the radio to the test set are required for this test. Receiver audio frequency response is expressed in dB error from a 6 dB/octave curve.

Pass/fail Limits Used

Pass/Fail Limit 2. RX Audio Rsp Dev From -6 dB/oct

Test Parameters Used

Parameter 8. RC Compandor Always On

Parameters 15-17. RX Audio Response Start, Step, and Stop Frequencies

Parameter 25. RX Set Audio Level

Parameter 26. RX Tolerance for Setting Audio Level

Testing Conditions Fixed by the Software

- A –50 dBm RF signal is applied to the receiver's antenna.
- The –50 dBm RF signal is modulated to deviate to 2.3 kHz at a 1 kHz rate with a SAT tone present and a reference reading is made.
- The frequency rate is then swept over the desired range and the response measured.
- If the compandor is always on, a 2:1 correction is applied to the measured results.
- Narrow analog operation uses 1.5 kHz deviation and DSAT.

TEST_16. RX Audio Distortion

This test measures the distortion from the receiver when a standard test tone is applied to the radio. *Audio connections from the radio to the test set are required for this test.*

Also, this test uses the CCITT audio filter if installed in the test set. Otherwise, it uses the C-Message filter, or both the 300 Hz HPF and 3 kHz LPF filters.

Pass/fail Limits Used

[Pass/Fail Limit 1. RX Audio Distortion](#)

Test Parameters Used

[Parameter 8. RC Compandor Always On](#)

[Parameter 25. RX Set Audio Level](#)

[Parameter 26. RX Tolerance for Setting Audio Level](#)

Testing Conditions Fixed by the Software

- A –50 dBm RF signal is applied to the receiver’s antenna.
- The –50 dBm RF signal is modulated to deviate to 2.3 kHz at a 1 kHz rate with a SAT tone present.
- Narrow analog operation uses 1.5 kHz deviation and DSAT.

TEST_17. RX Hum and Noise

This test measures the ratio, expressed in dB, of:

- The residual audio output in the absence of modulation,
- To the rated audio output.

Audio connections from the radio to the test set are required for this test.

Pass/fail Limits Used

[Pass/Fail Limit 5. RX Hum and Noise](#)

Test Parameters Used

[Parameter 8. RC Compandor Always On](#)

[Parameter 25. RX Set Audio Level](#)

[Parameter 26. RX Tolerance for Setting Audio Level](#)

Testing Conditions Fixed by the Software

- A –50 dBm RF signal is applied to the receiver’s antenna.
- The –50 dBm RF signal is modulated to deviate to 6.4 kHz at a 1 kHz rate with a SAT tone present.
- The SAT tone is always on during this test.
- Narrow analog operation uses 3 kHz deviation and DSAT.
- The CCITT (or C-message filter) is used if present.
- The phone’s transmitter is not on.
- The ac voltmeter rms detector is used to measure the reference level and hum and noise.

TEST_18. RX SINAD

This test sets and measures the ratio, expressed in dB, of:

- Signal + Noise + Distortion,
- to Noise + Distortion.

The receiver SINAD is measured at the RF level for SINAD specified by test parameter 23. (If test parameter 13 is set to 1, then receiver SINAD is measured at the RF level for SINAD at extremes specified by test parameter 24). *Audio connections from the radio to the test set are required for this test.*

Receiver SINAD is measured at the receiver's audio output. This measurement differs from a distortion measurement in that it is usually conducted at low RF input levels where the noise contribution is significant.

This test is intended to measure receiver sensitivity. Receivers are typically required to provide at least 12 dB SINAD (less than 25% noise and distortion) for RF input levels below 1 microvolt.

Pass/fail Limits Used

Pass/Fail Limit 8. RX SINAD

Test Parameters Used

If test parameter 13 is set to test at extremes, then SINAD is measured using test parameter 24, RX RF level for SINAD at extremes at high, medium, and low supply voltages (only if an external power supply has been configured to be used over HP-IB by the HP 8920A).

- Parameter 8. RC Compandor Always On**
- Parameter 10. RT High Supply Voltage**
- Parameter 11. RT Low Supply Voltage**
- Parameter 12. RT Nominal Supply Voltage**
- Parameter 13. RT Test at Extreme Settings**
- Parameter 23. RX RF Level for SINAD**
- Parameter 24. RX RF Level for SINAD at Extremes**
- Parameter 25. RX Set Audio Level**
- Parameter 26. RX Tolerance for Setting Audio Level**

Testing Conditions Fixed by the Software

- The RF generator within the test set produces an RF carrier with an amplitude determined by test parameter 23: RF level for SINAD.
- The RF carrier is modulated to deviate to 2.3 kHz at a 1 kHz rate with a SAT tone present.
- If test parameter 13 is set to 1, then RF carrier amplitude is determined by test parameter 24, and the measurement is repeated at high and low supply voltages.
- Narrow analog operation uses 1.5 kHz deviation and DSAT.
- If present, the CCITT psophometric bandpass filter will be used. If not, the C-Message bandpass filter will be used. If not, the 300 Hz HPF and 3 kHz LPF will be used.

TEST_19. RX FVC Order Message Error Rate

This test simulates a Forward Voice Channel (FVC) order message being sent from a cell site to the cellular radio and measures the Order Message Error rate.

The test works as follows:

- A Forward Voice Channel (FVC) audit message is sent 100 times and the number of acknowledgments from the UUT is counted.
- The RF level is set by test parameter 21.
- If the UUT misses 10 acknowledgments in a row the test terminates.

FVC order message error rate is expressed in % .

Pass/fail Limits Used

Pass/Fail Limit 7. RX Order Message Error Rate (OMER)

Test Parameters Used

Parameter 21. RX FVC Message Error Rate RF Level

Parameter 41. TX TS Atten for Signaling

TEST_20. CP Release

This test simulates a cellular radio executing a release from the cell site after obtaining a voice channel.

The test works as follows:

- A release message is sent from the test set, then it waits two seconds before measuring the TX output power.
- You may use the following parameters to select your desired units for test results output:
 - dBWatts - Set parameter 42 *TX Units for Power Meas* to 0=dBW
 - Watts - Set parameter 42 *TX Units for Power Meas* to 1=Watts
 - dBm - Set parameter 14 *RT use DUPLEX OUT & ANT IN* to 1=yes, and use the DUPLEX OUT port for the forward channel, and the ANT IN port for the reverse channel.
- The output power should be < -25 dBW for the test to pass.

Test Parameters Used

- [Parameter 14. RT use DUPLEX OUT & ANT IN](#)
- [Parameter 42. TX Units for Power Meas](#)

TEST_21. CP Origination

This test simulates a call from the cellular phone to the base station (cell site). Specifically, this test does the following:

1. The test set simulates a control channel.
2. The operator is instructed to dial 123 123 4567 after the UUT has service. (Service is indicated by the NO SERVICE light going off on the UUT.)
3. Performs 3 of 5 majority voting on the Reverse Control Message.
4. Performs BCH error detection and correction of the Reverse Control Message, Wideband data.
5. Tests each section of the origination message, bit by bit.
6. Sends an Initial-Voice-Channel-Designation order to the UUT directing it to tune to a voice channel obtained from the **Channel Information** (or **Edit Freq**) table.

If the channel number from the table has an N suffix, the phone will be directed to a narrow voice channel. If the channel number has no suffix, the phone will be directed to a wide voice channel.

Test Parameters Used

Parameter 4. CP Control Channel

Parameter 5. CP DSAT Vector

Parameter 6. CP Prt RECC RVC Data

Parameter 7. CP SAT Tone

Parameter 22. RX RF Level for Signaling

Parameter 41. TX TS Atten for Signaling

TEST_22. OT No Audio Functional

These tests are designed to provide you with a quick evaluation of the cellular radio receiver and transmitter without the need for audio connections from the radio to the test set. The following tests are performed:

- **TEST_03. TX Frequency Error**
- **TEST_04. TX Carrier Power**
- **TEST_08. TX Signaling Tone/DST**
- **TEST_10. TX SAT/DSAT**
- **TEST_11. TX RVC Data Deviation**
- **TEST_27. CP Hook Flash**
- **TEST_20. CP Release**
- **TEST_21. CP Origination**
- RX tones functional
- RX SINAD functional
- TX microphone functional

The first eight tests in the above list are described individually in this chapter. The final three tests are available only as part of this test and they work as follows:

- When prompted, the operator is required to listen for tones from the receiver, and then select whether the test passed or failed.
- The operator is required to whistle into the transmitter and observe the deviation on the test set, and then select whether the test passed or failed.

Test Parameters Used

- **Parameter 8. RC Compandor Always On**
- **Parameter 22. RX RF Level for Signaling**
- **Parameter 23. RX RF Level for SINAD**

Also, see individual test descriptions for additional pass/fail limits and test parameters associated with each test.

TEST_23. TX Quick General

These tests are designed to provide you with a quick evaluation of the cellular radio's transmitter capabilities. *Audio connections from the radio to the test set are required for this test.* The following tests are included:

- TEST_04. TX Carrier Power**
- TEST_03. TX Frequency Error**
- TEST_05. TX Peak Frequency Deviation**
- TEST_07. TX Audio Distortion**
- TEST_06. TX Audio Frequency Response**
- TEST_12. TX Compressor Response**
- TEST_09. TX FM Hum and Noise**
- TEST_11. TX RVC Data Deviation**
- TEST_10. TX SAT/DSAT**
- TEST_08. TX Signaling Tone/DST**

Also, see individual test descriptions for additional pass/fail limits and test parameters associated with each test.

Test Parameters Used

- Parameter 8. RC Compandor Always On**
- Parameter 22. RX RF Level for Signaling**

TEST_24. RX Quick General

These tests are designed to provide you with a quick evaluation of the cellular radio's receiver capabilities. *Audio connections from the radio to the test set are required for this test.* The following tests are performed:

- TEST_18. RX SINAD**
- TEST_16. RX Audio Distortion**
- TEST_15. RX Audio Frequency Response**
- TEST_14. RX Expander**
- TEST_17. RX Hum and Noise**

Test Parameters Used

- Parameter 8. RC Compressor Always On**
- Parameter 22. RX RF Level for Signaling**
- Parameter 25. RX Set Audio Level**
- Parameter 26. RX Tolerance for Setting Audio Level**

Also, see individual test descriptions for additional pass/fail limits and test parameters associated with each test.

TEST_25. CP Flow Chart

This test displays a flow-chart representing a cellular phone as it gains access to a system. Once a voice channel is obtained, you can test cellular-radio functions including handoffs, power-level changes, SAT/DSAT changes, hook flashes, and clearing the system. At each stage, reverse channel data is displayed for analysis, along with measurements of power, frequency error, deviation, and SAT.

Test Parameters Used

Parameter 3. AC MIN From? [0=RECC,1=All 0's,2=Phone #]

Parameter 4. CP Control Channel

Parameter 5. CP DSAT Vector

Parameter 6. CP Prt RECC RVC Data

Parameter 7. CP SAT Tone

Parameter 9. RT External Path Loss

Parameter 14. RT use DUPLEX OUT & ANT IN

Parameter 22. RX RF Level for Signaling

Parameter 41. TX TS Atten for Signaling

Parameter 42. TX Units for Power Meas

Running the MANUAL Test Procedure

The MANUAL Test Procedure uses TEST_25. There are a few things you need to know when you run this test.

- At the beginning of this test, the test set simulates a control channel. The cellular phone must tune to this control channel and decode the data stream in order to obtain service. When the phone succeeds at obtaining service, the NO SERVICE indicator on the phone will turn off. The control channel can be changed by selecting the **Cntl Chan** field.
- If the cellular phone fails to obtain service, refer to [chapter 6, "Problem Solving," on page 255](#) for help.
- When the cellular phone first obtains service, a phone registration must be done before paging can be done.

To register the phone, select the **Regist** field.

- After a phone registration is done, phone paging can be done.

Select the **Page** field to page the phone.

Dial a number and press the phone's SEND key to initiate an origination. Registration is not required for origination.

- Once a voice channel is obtained, refer to the flowchart on the screen and the associated fields to the right of the screen for operating functions.
 - **maintenance** allows you to run a maintenance check of the phone's signaling tone, frequency, and deviation. For a narrow voice channel, the value of the digital signaling tone (DST) sequence is displayed in hexadecimal.
 - **clear ls** allows you to clear the land station (ls).
 - **clear ms** allows you to clear the mobile station (ms).
 - **chng chan** allows you to change cellular phone channels. This performs a handoff. (The phone is instructed to use power level 0 when it changes to the new channel).
 - **chng pwr** allows you to change cellular phone power.
 - **chng sat/dsat** allows you to change the Supervisory Audio Tone (SAT or DSAT).
 - **DTMF** allows you to measure the frequency error of the high tone and low tone from the DTMF generator in the phone (for one keypad number at a time).
 - **Hook Flash** allows you to transmit a hook flash number from the phone and receive and display it on the test set.

TEST_26. TX Switch Channels

This test measures transmitter frequency error, power, and SAT frequency error over a range of channels defined by test parameters 38-40.

The test works as follows:

- The UUT's channel number is changed over the desired range indicated by test parameters 38-40 (using the handoff message).
- The channels will all be wide voice channels or they will all be narrow voice channels as determined by the currently active entry in the **Channel Information** (or **Edit Freq**) table. (If you have multiple wide and narrow channels listed in the **Channel Information** (or **Edit Freq**) table, then the TX Switch Channel test will repeat, testing the same sequence of channels specified by test parameters 38-40, but the channels will be wide or narrow as determined by the currently active entry in the **Channel Information** (or **Edit Freq**) table).
- For each wide channel, the TX output power (at power level 0 only), RF frequency error, and SAT frequency error is measured.
- For each narrow channel, the TX output power (at power level 0 only) and RF frequency error are measured and the DSAT sequence coming from the phone is decoded and displayed.
- Each time the channel is changed, the SAT frequency is changed to the next valid SAT tone or DSAT value.

Pass/fail Limits Used

- 11 TX carrier power at level 0 (used for Power Class 1)
 - 12 TX carrier power at level 1 (used for Power Class 2)
 - 13 TX carrier power at level 2 (used for Power Class 3)
- (See [Pass/Fail Limits 11-18. TX Carrier Power @Levels 0-7](#))
- [Pass/Fail Limit 25. TX Frequency Error](#)
 - [Pass/Fail Limit 33. TX SAT Frequency Error](#)

Test Parameters Used

- [Parameter 8. RC Compandor Always On](#)
- [Parameter 13. RT Test at Extreme Settings](#)
- [Parameter 22. RX RF Level for Signaling](#)
- [Parameters 38-40. TX Switch Channels Start, Step, and Stop Channel 1](#)
- [Parameter 42. TX Units for Power Meas](#)

TEST_27. CP Hook Flash

This test verifies that the correct hook-flash number (3 digits) is correctly sent by the cellular radio.

The test works as follows:

1. A voice channel is established.
2. The operator is prompted to dial a 3-digit number and press the SEND key on the UUT.
3. If the channel is a wide voice channel, the test detects the resulting signaling tone from the UUT and sends a “send-called-address” order to the UUT on the Forward Voice Channel (FVC). This step does not occur on narrow voice channels.
4. The test receives the hook-flash number from the UUT on the Reverse Voice Channel and displays it. (The number is not compared to a specific value or number.)

Test Parameters Used

[Parameter 6. CP Prt RECC RVC Data](#)

[Parameter 41. TX TS Atten for Signaling](#)

TEST_28. TX DTMF Frequency Error

This test measures the transmitter's Dual-Tone Multifrequency (DTMF) frequency error for the phone's key pad. The low tone (LT) and high tone (HT) DTMF frequencies for each selected key are checked to make sure that the frequencies are within the DTMF frequency error limits for their nominal values.

DTMF frequency error is expressed in %.

Applications:

There are two groups of sinusoidal high and low frequencies consisting of 1209, 1336, and 1477 Hz (HT's) in one group, and 697, 770, 852, and 941 Hz (LT's) in the other group.

A DTMF signal is generated when a key is pressed on the handset. Each dialing key makes use of one assigned frequency from each group. The DTMF signal is encoded and transmitted for control purposes when dialing an origination from the phone.

Pass/fail Limits Used

[Pass/Fail Limit 23. TX DTMF Frequency Error](#)

Test Parameters Used

[Parameter 8. RC Compandor Always On](#)

[Parameter 22. RX RF Level for Signaling](#)

Test Parameter Descriptions

Test parameters are used to define the conditions under which a test will run. You may edit the test parameters to change the default values to meet your specific testing needs and conditions. Test parameters may be used in one or more tests.

For information on editing test parameters, see ["How to Customize Testing" on page 33 in chapter 2.](#)

Test parameters remain in battery-backed-up memory until you select a procedure to run. If you wish to prevent them from being lost when a new procedure is selected, you will have to save them in a procedure. See ["Saving a Test Procedure" on page 50 in chapter 2.](#)

To print the list of test parameters, see ["To print test results:" on page 229 in chapter 5.](#)

There are several different types of test parameters:

- Receiver/Transmitter Test Parameters (RT)
- Receiver Test Parameters (RX)
- Transmitter Test Parameters (TX)
- Extra Test Parameters (XX)

NOTE: Refer to [chapter 2, "Using the Software/HP 8920B, or HP 8920A FW Above Rev. A.14.00," on page 23](#) in this manual for details about selecting test parameters for your FM radio.

Parameter 1. AA Enter Ph#?

This parameter specifies from where the test will get the phone number of the UUT. You may enter one of three options:

- 0
- 1
- the 10 digit phone number of the UUT

Setting Parameter 01 **AA Enter Ph#?** to **0=If Needed** tells the test set to prompt the user for the phone number of the UUT if:

- The phone number is needed to perform the first test in a test sequence, AND
- A MIN was not obtained by the test set running a previous test procedure.

Setting Parameter 01 to **1=Always** tells the test set to prompt the user for the phone number of the UUT each time the test procedure is run. (Note that if Parameter 03 **AC MIN From?** is set to **1=All 0's** indicating an all zero MIN, the user is not prompted for a phone number). Setting Parameter 01 to anything other than **0=If Needed** or **1=Always** will cause the test set to use the number entered as a ten digit phone number for paging the UUT if one of the following conditions are also true:

- Parameter 03 **AC MIN From?** is set to **2=Phone #**, indicating to the test set to get the MIN from the phone number.
- Parameter 03 is set to **0=RECC** and a MIN has not been previously entered into the test set by running a previous test procedure.

Example

If Parameter 01 is set to **1231234567** and Parameter 03 is set to **2=Phone#**, the test set will use a MIN corresponding to phone number 123-123-4567 to page the UUT.

NOTE:

If a registration or an origination is performed that causes a new MIN to be entered into the test, this new MIN will then be used instead of the MIN derived from the entered phone number.

Used in Tests

All tests (when a system initialization is done by the software).

Parameter 2. AB AID Number

This test parameter is used to identify the Area Identification Number (AID) for the cellular phone's traffic area.

For Example:

If the UUT's AID number is 11100, you would enter **11100** as the value.

It's Used in the Following Tests:

All Tests (when a System Initialization is done by the software)

Parameter 3. AC MIN From?

This parameter specifies from where the test set will get the Mobile Identification Number (MIN) of the UUT.

Setting Parameter 03 to **0=RECC** causes the test set to get the MIN from the Reverse Control Channel (RECC) Data. The RECC Data (data sent on the control channel from the UUT to the test set) sent during a registration or an origination is read by the test set to obtain the MIN.

Setting Parameter 03 to **1=All 0's** causes the test set to use a MIN consisting of all zeros. An all zero MIN is an invalid MIN according to the IS-54 standard. Because some phones initially have an all zero MIN after being manufactured or serviced, this parameter (when set to **1=All 0's**) allows the test set to page phones with an all zero MIN.

NOTE: An all zero MIN can also be entered into the test set by setting parameter 03 to **0=RECC** and getting the MIN from the RECC Data from a UUT that has an all zero MIN.

NOTE: If Parameter 03 is set to **1=All 0's**, then Parameter 01 AA Enter Ph#? is not used.

Setting Parameter 03 to **2=Phone #** causes the test set to derive the MIN from the phone number, depending on the entry in Parameter 01 **AA Enter Ph#?** described below:

- If Parameter 01 contains a phone number, the phone number in Parameter 01 is used to derive a MIN.
- If Parameter 01 is set to **0=If Needed** or **1=Always**, the user will be prompted for a phone number if needed. This phone number will be used to derive the MIN.

NOTE: If a registration or an origination test is performed that causes a new MIN to be entered into the test set, this new MIN will then be used instead of the MIN obtained as specified by Parameter 03.

Used in Tests

All tests (when a system initialization is done by the software).

Parameter 4. CP Control Channel

This test parameter is used to identify the control channel used by the UUT. Cellular phones that work on only one system need to specify the correct control channel in order to allow the phone to get into the “ROAM” state.

There are two groups of dedicated control channels: 418 through 440, and 520 through 542 (even numbered channels only).

For Example:

If you want to use control channel 520 to set up a call with the UUT, you would enter **520** as the value.

It’s Used in the Following Tests:

All Tests (where a forward control channel is obtained)

Parameter 5. CP DSAT Vector

This test parameter allows you to set the Digital Supervisory Audio Tone (DSAT) sequence to be used on narrow voice channels:

The seven valid sequences are as follows:

#0 = 2556CB

#1 = 255B2B

#2 = 256A9B

#3 = 25AD4D

#4 = 26AB2B

#5 = 26B2AD

#6 = 2969AB

For Example:

If you want the first sequence shown above, you would enter a **0** as the value.

It's Used in the Following Tests:

All Tests (whenever a narrow voice channel is obtained)

Parameter 6. CP Prt RECC RVC Data

This test parameter allows you to print the Reverse Control Channel (RECC) and Reverse Voice Channel (RVC) messages to the display or printer.

The RECC message is a wideband data stream sent from the mobile station to the land station, and can consist of up to five words. The types of messages that can be transmitted over the RECC are:

- Page Response Message
- Origination Message
- Order Confirmation Message
- Order Message

The RVC message is a wideband data stream sent from the mobile station to the land station, and can consist of one or two words. The types of messages that can be transmitted over the RVC are:

- Order Confirmation Message
- Called-Address Message

It's Used in the Following Tests:

All Tests (whenever the RECC or RVC messages are analyzed during testing)

Parameter 7. CP SAT Tone

This test parameter allows you to set the Supervisory Audio Tone (SAT) frequency to be used on wide voice channels.

For Example:

If you want the SAT to be at 6000 Hz, you would enter 6000 as the value. All values are entered in Hz.

It's Used in the Following Tests:

All Tests (whenever a wide voice channel is obtained)

Parameter 8. RC Compandor Always On

This test parameter allows you to indicate whether or not the compandor is always on.

If this test parameter is set to **1** (Yes), the program assumes that the UUT's compressor circuitry is located before the pre-emphasis circuitry on the transmitter, and behind the de-emphasis circuitry in the receiver.

With the compandor always "ON" (set to **1**), the effects of an "ideal expandor" are removed from the test results (of the RX Audio Frequency Response test 15, that is, the results are reduced in half). Also, the test operator is not prompted to turn the compandor "ON" and "OFF".

If this test parameter is set to **0** (No), then the test operator will be prompted to "turn the Radio compandor ON" during testing. Some manual control of the phone's compandor state is required.

For Example:

If you do not want the compandor always on, you would enter **0** as the value. The value must be either a **0** for no, or a **1** for yes.

It's Used in the Following Tests:

All Tests (except Tests 01 - 04, 13, 19 - 21, 25, and 27)

Parameter 9. RT External Path Loss

This test parameter allows you to set the amount of loss for any external cables or pads (attenuators) connected to the test set. Also use this test parameter to compensate for path loss when the RF link between the cellular phone and the test set is accomplished via antennas (see test [Parameter 14. RT use DUPLEX OUT & ANT IN](#)). This loss is compensated for in power measurements and in signal generator level settings on the test set.

For Example:

If a 30 dB attenuator is connected in line with the UUT antenna, you would enter 30 as the value. The value must be entered in dB.

It's Used in the Following Tests:

All Tests (whenever a System Initialization is done by the software)

Parameter 10. RT High Supply Voltage

This test parameter is used to set the UUT to the highest voltage rating that it is specified to operate at under extreme conditions. The high-supply voltage is set only when an external power supply is connected to the test set over HP-IB.

Test Parameter 13, RT Test at Extreme Settings, must be set to **1=yes** for test parameter 10 to be activated.

For Example:

If you want to set the power supply voltage to operate the UUT at +20% of the normal (Nominal) supply voltage, and your Nominal Supply Voltage is 13.2V, you would enter **15.8** as the value.

The value must be entered in Vdc.

It's Used in the Following Tests:

TEST_03. TX Frequency Error
TEST_04. TX Carrier Power
TEST_18. RX SINAD

Parameter 11. RT Low Supply Voltage

This test parameter is used to set the UUT to the lowest voltage rating that it is specified to operate at under extreme conditions. The low-supply voltage is set only when an external power supply is connected to the test set over HP-IB.

Test Parameter 13, RT Test at Extreme Settings, must be set to **1=yes** for test parameter 11 to be activated.

For Example:

If you want to set the power supply voltage to operate the UUT at –20% of the normal (Nominal) supply voltage, and your Nominal Supply Voltage is 13.2V, you would enter **10.6** as the value.

The value must be entered in Vdc.

Used in the Following Tests:

TEST_03. TX Frequency Error
TEST_04. TX Carrier Power
TEST_18. RX SINAD

Parameter 12. RT Nominal Supply Voltage

This test parameter is used to set the UUT to its nominal voltage rating that it is specified to operate at under normal conditions. This test parameter is needed only when using a stand-alone power supply or battery-operated phone.

For Example:

If you want to set the power supply voltage to operate the UUT at 13.2V, you would enter **13.2** as the value.

The value must be entered in Vdc.

It's Used in the Following Tests:

All Tests (whenever a System Initialization is done by the software)

Parameter 13. RT Test at Extreme Settings

This test parameter is used to activate all of the test parameters that set extreme testing conditions for the UUT. If this test parameter is set to **1** (yes), the following test parameters may be used:

- 10. RT High Supply Voltage
- 11. RT Low Supply Voltage
- 24. RX RF Level for SINAD at Extremes

The software offers the capability to run certain tests at extreme supply voltage conditions. Extreme supply voltage conditions are high and low supply voltages that are used while testing is conducted. In order to use the extreme testing conditions, an HP-IB programmable power supply must be used. This power supply must be interfaced to the test set through an HP-IB interface cable. For more information on the types of power supplies supported by the software and how to configure the test system to control the power supply, see "[Configuring an HP-IB Power Supply](#)" on page 108 located in the description of "[TEST_13. TX Current Drain](#)" on page 107.

For Example:

When this test parameter is set to **0**, the following tests are performed at the nominal dc power supply voltage. When this test parameter is set to **1**, the tests are performed at nominal, high, and low supply voltages.

It's Used in the Following Tests:

- [TEST_03. TX Frequency Error](#)
- [TEST_04. TX Carrier Power](#)
- [TEST_18. RX SINAD](#)

Parameter 14. RT use DUPLEX OUT & ANT IN

This test parameter allows you to select the RF ports on the test set which will be used for cellular phone tests. A value of 0 causes the RF IN/OUT port to be used for both forward and reverse channels. A value of 1 causes the DUPLEX OUT port to be used for the forward channel and the ANT IN port to be used for the reverse channel.

Use of the DUPLEX OUT and ANT IN ports allows the RF link between the test set and the cellular phone to be established via antennas instead of coaxial cable. In either case, test parameter 9: RT External Path Loss should be used to compensate for the path loss.

NOTE: If the RF link is accomplished via antennas, it must be done inside a shielded environment to avoid interference with local cellular telephone service.

It's Used in the Following Tests:

It is used in all tests.

Parameters 15-17. RX Audio Response Start, Step, and Stop Frequencies

The *RX Audio Frequency Response Start Frequency* is the lowest modulation frequency used in the *RX Audio Frequency Response* test.

The *RX Audio Frequency Response Step Frequency* is the step-size used to vary the modulation frequency in the *RX Audio Frequency Response* test.

The *RX Audio Frequency Response Stop Frequency* is the highest modulation frequency used in the *RX Audio Frequency Response* test.

These test parameters are used to set the start, stop and step frequency settings as the *RX Audio Frequency Response* test measures the degree of closeness to which the audio output of a receiver follows the 6 dB/octave de-emphasis curve.

For Example:

If you want the modulation frequency to be varied from 300 Hz to 3000 Hz in 500 Hz steps:

- You would enter **.3** as the *Audio Response Start Frequency* value.
- You would enter **.5** as the *Audio Response Step Frequency* value.
- You would enter **3** as the *Audio Response Stop Frequency* value.

The value must be entered in kHz.

It's Used in the Following Test:

[TEST_15. RX Audio Frequency Response](#)

Parameters 18-20. RX Expander Start, Step, and Stop Levels

The *RX Expander Start Level* is the highest frequency deviation relative to the zero crossing level that is used in the *RX Expander* test. It is expressed in dB.

The *RX Expander Step Level* is the step-size used to vary the frequency deviation in the *RX Expander* test. It is expressed in dB.

The *RX Expander Stop Level* is the lowest frequency deviation relative to the zero crossing level that is used in the *RX Expander* test. It is expressed in dB.

These test parameters are used to set the start, step, and stop “relative” input levels to the Expander circuitry for checking the output voltage-level changes for each input deviation.

For Example:

If you want to measure the Expander’s operating range over which it provides a nominal output level change of 2 dB for an input level change of 1 dB:

- You might enter **10** as the *Expander Start* value.
- You might enter **-5** as the *Expander Step* value.
- You might enter **-20** as the *Expander Stop* value.

The value must be entered in dB.

It’s Used in the Following Test:

TEST_14. RX Expander

NOTE: The sweep must go from high values to low values of the deviation applied for the test to update properly (i.e., the step value must be a negative number).

Parameter 21. RX FVC Message Error Rate RF Level

This test parameter sets the RF level for testing the Forward Voice Control (FVC) order message error rate.

For Example:

If you want the RF level for testing the FVC order message error rate to be at -110 dBm, you would enter -110 as the value.

The value must be entered in dBm.

It's Used in the Following Test:

[TEST_19. RX FVC Order Message Error Rate](#)

Parameter 22. RX RF Level for Signaling

This test parameter sets the test set's RF signal generator level for acquiring the forward control channel in all tests.

For Example:

If you want to apply a -50 dBm signal, you would enter -50 as the value.

The value must be entered in dBm.

NOTE: If the value entered is higher than -50 dBm, it may affect TEST_04. TX Carrier Power.

It's Used in the Following Tests:

It is used in all tests.

Parameter 23. RX RF Level for SINAD

This test parameter sets the RF signal level for measuring SINAD.

For Example:

If you want the RF signal level to be at -116 dBm for SINAD measurements, you would enter **-116** as the value.

The value must be entered in dBm.

It's Used in the Following Tests:

TEST_18. RX SINAD

TEST_22. OT No Audio Functional

Parameter 24. RX RF Level for SINAD at Extremes

This test parameter sets the RF signal level for measuring SINAD when measurements are done at extreme power supply voltage-level settings.

Test Parameter 13, RT Test at Extreme Settings must be set to “yes” for Test Parameter 24, RX RF Level for SINAD at Extremes to be activated.

For Example:

If you want the RF signal level to be at –113 dBm for SINAD measurements, you would enter –113 as the value.

The value must be entered in dBm.

It's Used in the Following Test:

[TEST_18. RX SINAD](#)

Parameter 25. RX Set Audio Level

This test parameter determines whether or not screen prompts are displayed to help the operator set the volume control during all of the receiver tests.

To use this test parameter, the test operator must have control or have access to the audio power (volume control) from the UUT's transceiver unit.

For Example:

If your radio is to be tested at 50% of rated audio power, enter the audio level in volts, for example 0.2 for 200 mV. The test operator is prompted to adjust to the correct volume level during testing. (The test set displays an "analog meter", correct adjustment is made when the meter needle is set in between the two longer lines on the meter.)

The value must be either a 0 for no, or a value for audio level in volts.

It's Used in the Following Tests:

- TEST_14. RX Expander**
- TEST_15. RX Audio Frequency Response**
- TEST_16. RX Audio Distortion**
- TEST_17. RX Hum and Noise**
- TEST_18. RX SINAD**
- TEST_24. RX Quick General**

Parameter 26. RX Tolerance for Setting Audio Level

This test parameter is used as the value of the maximum percentage of error that you are allowed for setting the UUT volume.

The value sets the tolerance window in the “analog meter” screen (refer to test ["Parameter 25. RX Set Audio Level" on page 148](#)) that is used to manually set the UUT volume during testing; the meter needle must be within the tolerance window (shown by two larger lines on the meter) before the program will accept the manually set UUT volume. The tolerance should be as accurate as the volume control will allow.

NOTE: This test parameter is only active when test parameter 25 (RX Set Audio Level) is set to accept audio level in volts.

For Example:

Enter the value as a percentage of the desired audio level. For example, if the UUT's rated audio output is 4 volts into an 8 ohm load, and the tolerance for setting volume is set to 5%, the window will be 4 volts $\pm 5\%$ (or 3.8 V to 4.2 V).

It's Used in the Following Tests:

- [TEST_14. RX Expandor](#)
- [TEST_15. RX Audio Frequency Response](#)
- [TEST_16. RX Audio Distortion](#)
- [TEST_17. RX Hum and Noise](#)
- [TEST_18. RX SINAD](#)
- [TEST_24. RX Quick General](#)

Parameters 27-29. TX Audio Response Start, Step, and Stop Frequencies

The *TX Audio Response Start Frequency* is the lowest input signal frequency used in the *TX Audio Frequency Response* test.

The *TX Audio Response Step Frequency* is the step-size used to vary the input signal frequency in the *TX Audio Frequency Response* test.

The *TX Audio Response Stop Frequency* is the highest input signal frequency used in the test. *TX Audio Frequency Response*

These test parameters are used to set the start, stop and step frequency settings by the TX Audio Frequency Response test to measure the degree of closeness to which the audio output of the transmitter follows the 6 dB/octave pre-emphasis curve.

For Example:

If you want the modulation frequency to vary from 300 Hz to 3000 Hz in 500 Hz steps:

- You would enter **.3** as the **TX Audio Response Start Frequency** value.
- You would enter **.5** as the **TX Audio Response Step Frequency** value.
- You would enter **3** as the **TX Audio Response Stop Frequency** value.

The value must be entered in kHz.

It's Used in the Following Test:

TEST_06. TX Audio Frequency Response

Parameter 30. TX Carrier Power Levels Tested

This test parameter allows you to measure the carrier power at any or at all of the power levels (0-7) shown below.

For Example:

If you want to measure the transmitter carrier power when it is at Power Levels 2 and 4, you would enter **20** as the value, as follows:

This test parameter's range is based upon a Binary Weighted Decimal (BWD). As shown in the table below, you choose the Power Levels that will be measured for carrier power and add their weighted values.

Table 3

Power Level	7	6	5	4	3	2	1	0
Weighted Value	128	64	32	16	8	4	2	1

The test parameter ranges from a minimum value of **1** to a maximum value of **255**.

It's Used in the Following Test:

[TEST_04. TX Carrier Power](#)

Parameters 31-33. TX Compressor Start, Step, and Stop Levels

The *TX Compressor Start Level* is the lowest relative input level to the compressor that is used in the *TX Compressor Response* test.

The *TX Compressor Step Level* is the step-size used to vary the input level to the compressor in the TX Compressor Response test. This must be a negative number for the test to work properly.

The *TX Compressor Stop Level* is the highest relative input level to the compressor that is used in the *TX Compressor Response* test.

These test parameters are used to set the start, step, and stop relative input levels to the Compressor circuitry for checking the output deviation for each input voltage level.

For Example:

If you want to measure the compressor's operating range over which it provides a nominal output level change of 1 dB for an input level change of 2 dB:

- You might enter **25** as the **TX Compressor Start** value.
- You might enter **-5** as the **TX Compressor Step** value.
- You might enter **-30** as the **TX Compressor Stop** value.

The values must be entered in dB.

It's Used in the Following Test:

[TEST_12. TX Compressor Response](#)

Parameter 34. TX Current Drain Levels Tested

This test parameter allows you to measure current drain at any or all of the power levels (0-7) shown below.

For Example:

If you want to measure the transmitter current drain on the UUT when it is at Power Levels 1 and 4, you would enter **18** as the value, as follows:

This condition's range is based upon a Binary Weighted Decimal (BWD). As shown in the table below, you choose the power levels that will be measured for current drain and add their weighted values.

Table 4

Power Level	7	6	5	4	3	2	1	0
Weighted Value	128	64	32	16	8	4	2	1

The test parameter ranges from a minimum value of **1** to a maximum value of **255**.

It's Used in the Following Test:

[TEST_13. TX Current Drain](#)

Parameter 35. TX De-emphasis

This test parameter allows you to turn on or off the de-emphasis filter on the test set in order to restore the received pre-emphasized signal.

For Example:

If you want to turn the de-emphasis filter in the test set off, you would enter **0** as the value.

The value must be entered as a **0** for off, or a **1** for on.

It's Used in the Following Test:

[TEST_07. TX Audio Distortion](#)

[TEST_09. TX FM Hum and Noise](#)

Parameter 36. TX Peak Frequency Deviation Step Frequency

This test parameter sets the peak frequency deviation step size for the TX Peak Frequency Deviation test. Peak frequency deviation is measured between a start frequency of 300 Hz and a stop frequency of 3000 Hz (both values set by the software).

For Example:

If you want modulation limiting measured in step sizes of 500 Hz, you would enter **0.5** as the value.

The value must be entered in kHz.

It's Used in the Following Test:

[TEST_05. TX Peak Frequency Deviation](#)

Parameter 37. TX Pk Freq Dev 50 Hz HPF

This test parameter allows you to control the 50 Hz high-pass filter (HPF) for the TX Peak Frequency Deviation test.

For Example:

If you want to use the 50 Hz HPF, you would enter **1** as the value. For a 0 value, the <20 Hz HPF filter is used.

It's Used in the Following Test:

TEST_05. TX Peak Frequency Deviation

Parameters 38-40. TX Switch Channels Start, Step, and Stop Channel

This test parameter allows you to set the start, step, and stop channels for the *TX Switch Channels* test.

For Example:

If you want to start the TX Switch Channels test at channel 100 and stop at channel 600, making sure that channels 200-500 are also tested, you would enter:

- 100 as the start channel value.
- 100 as the step channel value.
- 600 as the stop channel value.

It's Used in the Following Test:

[TEST_26. TX Switch Channels](#)

Parameter 41. TX TS Atten for Signaling

This test parameter sets the input attenuation in the test set RF Analyzer to attenuate the signal which is input to the test set (TS).

For Example:

If you want to have a 20 dB input attenuation to the test set, you would enter **20** as the value.

Values are entered as 0, 20, or 40 dB.

It's Used in the Following Tests:

All Tests (whenever signaling is done).

Parameter 42. TX Units for Power Meas

This test parameter allows you to choose between dBWatts and Watts units for measuring the transmitter's RF power.

Values are entered as a 0 for dBW, or as a 1 for Watts. The value of this test parameter also determines whether the entries for pass/fail limits 11 through 18 will be interpreted as watts or dBw.

It's Used in the Following Tests:

- [TEST_04. TX Carrier Power](#)
- [TEST_25. CP Flow Chart](#)
- [TEST_26. TX Switch Channels](#)

Parameter 43. TX Voltage for Compressor Zero Crossing

This test parameter sets the voltage that is used to modulate the UUT transmitter (often called microphone sensitivity) for the purpose of measuring the resulting frequency deviation and comparing it to a specified compressor zero reference deviation.

For Example:

If you want the peak deviation of the carrier to occur at the zero reference point when 0.1 Vrms is applied to the transmitter microphone input, you would enter **.1** as the value.

The value must be entered in Vrms.

It's Used in the Following Test:

- TEST_05. TX Peak Frequency Deviation**
- TEST_06. TX Audio Frequency Response**
- TEST_07. TX Audio Distortion**
- TEST_09. TX FM Hum and Noise**
- TEST_12. TX Compressor Response**

Parameter 44. TXT Trnsient/SS Data

This parameter requires trigger delay capabilities only available on the HP 8920B. HP 11807A software will ignore this parameter.

For HP 11807E software, this parameter allows the user to select between three modes of operation for the execution of TEST_11 TX RVC Data Deviation.

- Select 0=tran (transient) to perform the test on the entire RVC data signal returned from the UUT.
- Select 1=bth (both) to perform the test on just the steady state portion of the RVC data signal followed by a test of the entire signal. This option uses trigger delay capabilities and can only be performed on an HP 8920B.
- Select 2=ss (steady state) to test only the steady state portion of the signal. This option uses trigger delay capabilities and can only be performed on an HP 8920B.

It's Used in the Following Test:

TEST_11. TX RVC Data Deviation

Pass/Fail Limit Descriptions

Pass/Fail Limits define the values a measurement's result is compared against to determine if the UUT meets its specified standards.

For information on editing pass/fail limits, see ["Customizing Testing" on page 32](#) in [chapter 2](#).

The list of pass/fail limits is arranged alphabetically. The first few capital letters in the title indicate what the pass/fail limit refers to (see Prefixes and Abbreviations at the beginning of this chapter).

Pass/Fail Limits remain in battery-backed-up memory until you select a procedure to run. If you wish to prevent them from being lost when a new procedure is selected you will have to save them in a procedure. See ["Saving a Test Procedure" on page 50](#) in [chapter 2](#). To print the list of Pass/Fail Limits, see ["To print TESTS screens:" on page 233](#) in [chapter 5](#).

There are two types of pass/fail limits:

- Receiver Test Pass/Fail Limits (RX)
- Transmitter Test Pass/Fail Limits (TX)

NOTE: Refer to [Chapter 2, "Using the Software/HP 8920B, or HP 8920A FW Above Rev. A.14.00," on page 23](#) in this manual for details about selecting pass/fail limits for your FM radio.

Pass/Fail Limit 1. RX Audio Distortion

This sets the pass/fail limits that are used when the receiver's audio distortion is measured while receiving the RF level for signaling (test parameter 22).

Pass/fail limits are determined by using any applicable standard, such as:

- JTACS Standard: Demodulation Distortion

For Example:

If your standard states that audio distortion produced by the demodulator should be at least 24 dB below the level of the fundamental frequency, you would enter **NO LIMIT** as the Lower Limit and **-24** as the Upper Limit.

Lower and Upper Limits must be entered in dB.

It's Used in the Following Test:

TEST_16. RX Audio Distortion

Pass/Fail Limit 2. RX Audio Rsp Dev From -6 dB/oct

This sets the pass/fail limits for the receiver's audio output circuitry, when its audio response is tested against a standard 6 dB/octave de-emphasis curve. The audio response should not deviate beyond the pass/fail limits over the frequency range of 400 to 2400 Hz.

Pass/fail limits are determined by using any applicable standard, such as:

- JTACS Standard: De-emphasis, and Bandpass Filter

For Example:

If your standard states that the audio response should not deviate more than +2 to -2 dB over the frequency range of 300 to 3000 Hz, you would enter -2 as the Lower Limit and 2 as the Upper Limit. (Check both limits.)

Lower and Upper Limits must be entered in dB.

It's Used in the Following Test:

[TEST_15. RX Audio Frequency Response](#)

Pass/Fail Limit 3. RX Expander Track Error

This sets the pass/fail limits that are used when the expander circuits are measured. The expander circuitry is required to follow its nominal 1:2 expansion characteristic with an output tolerance determined by this pass/fail limit.

Pass/fail limits are determined by using any applicable standard, like: JTACS
Standard: Expander

For Example:

If your standard sets the output voltage tolerance to be ± 1 dB from the Expander curve shown below, you would enter **-1** as the Lower Limit and **1** as the Upper Limit. Lower and Upper Limits must be entered in dB.

It's Used in the Following Test:

TEST_14. RX Expander

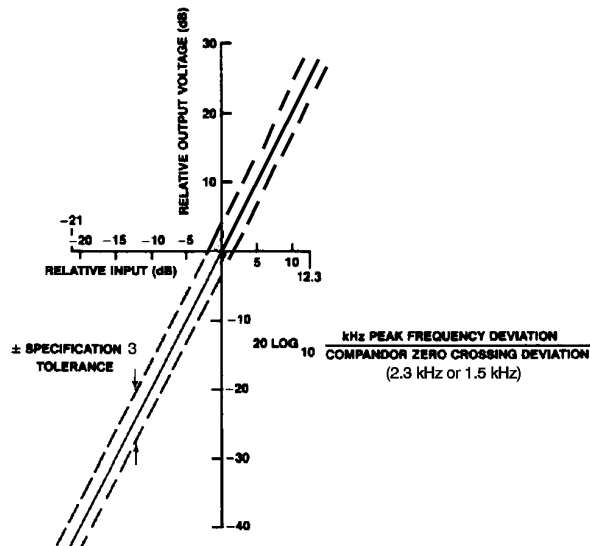

Pass/Fail Limit 4. RX Expander Zero Reference Level

This sets the pass/fail limits that are used when the expander's 0 dB reference level is measured on wide voice channels.

For Example:

If you state that the output voltage from the receiver should be -20 dBV rms ± 1 dB (with 2.3 kHz deviation applied), you would enter -21 as the Lower Limit and -19 as the Upper Limit. (Check both limits.)

Lower and Upper Limits must be entered in dBV rms.

It's Used in the Following Test:

TEST_14. RX Expander

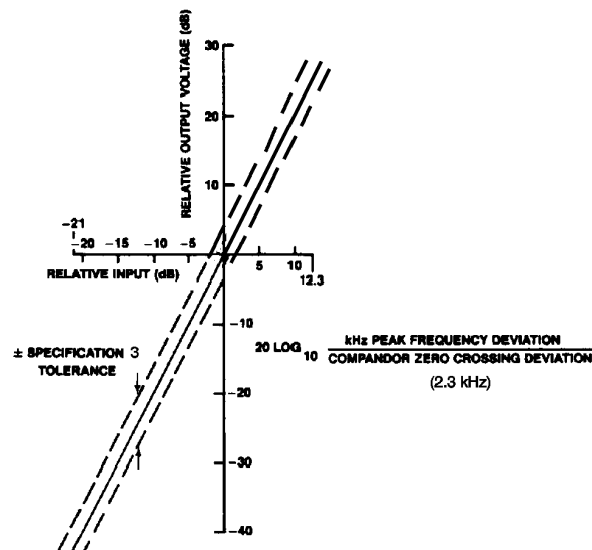

Pass/Fail Limit 5. RX Hum and Noise

This sets the pass/fail limits for the hum and noise level of the receiver.

Pass/fail limits are determined by using any applicable standard, such as:

- JTACS Standard: Demodulation Distortion

For Example:

If your standard sets the hum and noise level of the receiver to be at least 26 dB below the audio output for a 1 kHz modulated RF carrier at -50 dBm having a ± 6.4 kHz peak frequency deviation, you would enter **NO LIMIT** as the Lower Limit and **-26** as the Upper Limit. (Check upper limits.)

Lower and Upper Limits must be entered in dB.

It's Used in the Following Test:

[TEST_17. RX Hum and Noise](#)

Pass/Fail Limit 6. RX NTACS Expandor Zero Reference Level

This sets the pass/fail limits that are used when the expander's 0 dB reference level is measured on narrow voice channels.

For Example:

If you state that the output voltage from the receiver should be -20 dBV rms ± 1 dB (with 1.5 kHz deviation applied), you would enter -21 as the Lower Limit and -19 as the Upper Limit. (Check both limits.)

Lower and Upper Limits must be entered in dBV rms.

It's Used in the Following Test:

TEST_14. RX Expandor

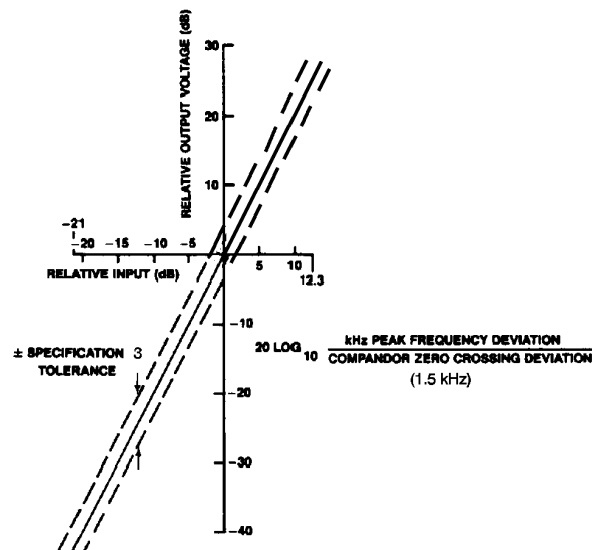

Pass/Fail Limit 7. RX Order Message Error Rate (OMER)

This sets the limits for testing the receiver as it processes the Forward Voice Control (FVC) order message.

Pass/fail limits are determined by using any applicable standard, such as:

- JTACS Standard: FVC Order Message

For Example:

If your standard states that the order-message error rate should not exceed 5%, you would enter 5 as the Upper Limit. (Check upper limits.)

Limits must be entered in percent.

It's Used in the Following Test:

[TEST_19. RX FVC Order Message Error Rate](#)

Pass/Fail Limit 8. RX SINAD

This sets the pass/fail limits used when SINAD is measured at the audio output of the receiver.

Pass/fail limits are determined by using any applicable standard such as:

- JTACS Standard: Maximum Usable Sensitivity / Field Strength Sensitivity

For Example:

If your standard defines the usable sensitivity measurement that results in 12 dB SINAD at the audio output of the receiver, you would enter **12** as the Lower Limit and **NO LIMIT** as the Upper Limit.

Lower and Upper Limits must be entered in dB.

It's Used in the Following Test:

TEST_18. RX SINAD

Pass/Fail Limit 9. TX Audio Distortion

This sets the pass/fail limits for the audio distortion that is acceptable in the transmitter.

Pass/fail limits are determined by using any applicable standard, such as:

- JTACS Standard: Modulation Distortion

For Example:

If your standard states that the transmitter distortion should be at least 26 dB below the level of the fundamental frequency, you would enter **NO LIMIT** as the Lower Limit and **-26** as the Upper Limit.

Lower and Upper Limits must be entered in dB.

It's Used in the Following Test:

[TEST_07. TX Audio Distortion](#)

Pass/Fail Limit 10. TX Audio Response Dev From 6 dB/Oct

This sets the pass/fail limits for the degree of closeness with which the frequency deviation of the transmitter follows the prescribed 6 dB/octave pre-emphasis characteristic curve over the range set by 27-29 TX audio response start, step and stop frequency test parameters.

Pass/fail limits are determined by any applicable standard, such as:

- JTACS Standard: Pre-emphasis

For Example:

If your standard states that from 300 to 3000 Hz the audio frequency response should not vary more than +2 to -2 dB from a true 6 dB/octave pre-emphasis curve, you would enter -2 as the Lower Limit and 2 as the Upper Limit.

Lower and Upper Limits must be entered in dB.

It's Used in the Following Test:

TEST_06. TX Audio Frequency Response

Pass/Fail Limits 11-18. TX Carrier Power @Levels 0-7

These set the pass/fail limits for the output power levels measured at the transmitter's output terminals while terminated in a 50 ohm load. Units for the pass/fail limits are set parameter 42 *TX Units for Power Meas* [0=dBW 1=Watts].

Pass/fail limits are determined by using any applicable standard, such as:

- EIA Standard: RF Power Output Requirements, RF Power Output

For Example:

If you are testing Power Class 1 radios and your standard lists the power levels and states that the output powers should be maintained within the range of +2 dB and -4 dB of nominal values over a specified temperature range, you would enter the following:

Table 5 Parameter 42 *TX Units for Power Meas* set to 0=dBW

Power Level	Nominal Value (dBW)	Lower Limit(dBW)	Upper Limit (dBW)
Level 0	4.5	0.5	6.5
Level 1	0.5	-3.5	2.5
Level 2	-3.5	-7.5	-1.5
Level 3	-7.5	-11.5	-5.5
Level 4	-11.5	-15.5	-9.5
Level 5	-15.5	-19.5	-13.5
Level 6	-19.5	-23.5	-17.5
Level 7	-23.5	-27.5	-21.5

Table 6 **Parameter 42 TX Units for Power Meas set to 1=Watts**

Power Level	Nominal Value (Watts)	Lower Limit(Watts)	Upper Limit (Watts)
Level 0	2.82	1.12	4.47
Level 1	1.12	0.447	1.78
Level 2	0.447	0.179	0.708
Level 3	0.179	0.0708	0.282
Level 4	0.0708	0.0282	0.112
Level 5	0.0282	0.0112	0.0447
Level 6	0.0112	0.00447	0.0178
Level 7	0.00447	0.00178	0.00708

NOTE: $\text{dBW} = 10 \log(\text{Watts})$

Table 7 **Parameter 42 TX Units for Power Meas set to 1=Watts**

Power Level	Nominal Value (dBW)	Lower Limit(dBW)	Upper Limit (dBW)
Level 0	4.5	0.5	6.5
Level 1	0.5	-3.5	2.5
Level 2	-3.5	-7.5	-1.5
Level 3	-7.5	-11.5	-5.5
Level 4	-11.5	-15.5	-9.5
Level 5	-15.5	-19.5	-13.5
Level 6	-19.5	-23.5	-17.5
Level 7	-23.5	-27.5	-21.5

If test parameter 42 is set to 0, the entries will be interpreted as dBW. If test parameter 42 is set to 1, the entries will be interpreted as Watts.

It's Used in the Following Tests:

TEST_04. TX Carrier Power

TEST_26. TX Switch Channels

Pass/Fail Limit 19. TX Compressor Track Error dB

This sets the pass/fail limits that are used when the compressor circuits are measured. The compressor circuitry is required to follow its nominal 1:2 compression characteristic with an output tolerance determined by this pass/fail limit.

Pass/fail limits are determined by using any applicable standard, such as:

- JTACS Standard: Compressor

For Example:

If your standard sets the output voltage tolerance to be ± 0.5 dB from the Compressor curve shown below, you would enter $-.5$ as the Lower Limit and $.5$ as the Upper Limit.

Lower and Upper Limits must be entered in dB.

It's Used in the Following Test:

TEST_12. TX Compressor Response

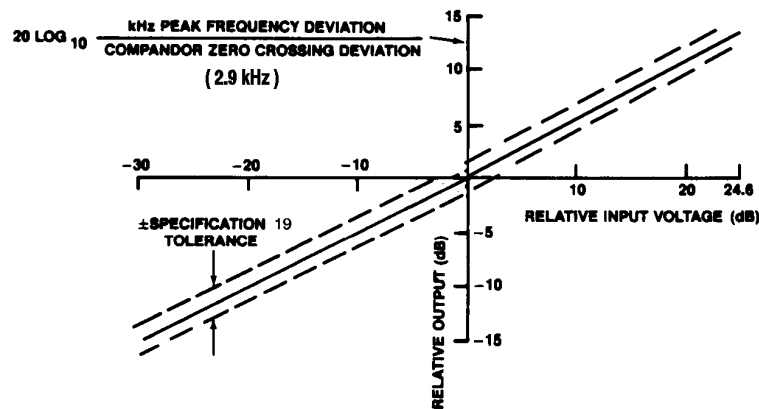

Pass/Fail Limit 20. TX Compressor Zero Reference Deviation

This sets the pass/fail limits that are used when the compressor's 0 dB reference deviation is measured on wide voice channels. The 0 dB reference deviation is found when a voltage input (the 43. TX voltage for compressor zero crossing test parameter) to the transmitter produces an output at the transmitter equal to the specified peak frequency deviation.

Pass/fail limits are determined by using any applicable standard, such as:

- JTACS Standard: Compressor

For Example:

If your standard states that the voltage input to the transmitter is a -15 dBV rms 1 kHz tone which produces 2.3 kHz $\pm 10\%$ peak frequency deviation of the carrier at the output of the transmitter, you would enter 2.07 as the Lower Limit and 2.53 as the Upper Limit.

Lower and Upper Limits must be entered in kHz.

It's Used in the Following Test:

[TEST_12. TX Compressor Response](#)

Pass/Fail Limit 21. TX Current Drain @Levels 0-3

This sets the pass/fail limits for current used by the transmitter when the radio is enabled to transmit at RF output power levels 0-3. This pass/fail limit is used whenever the test set performs a system initialization prior to running a test when an external power supply is connected over HP-IB.

Pass/fail limits are determined by using any applicable pass/fail limit, such as:

- UUT Pass/fail Limit: Current Consumption, Transmit

For Example:

If your UUT pass/fail limit defines the transmitter's current consumption to be 4 Amps for RF output power levels 0-3, you might enter **1** as the Lower Limit and **4** as the Upper Limit.

Lower and Upper Limits must be entered in Amps.

It's Used in the Following Test:

It is used in all tests.

Pass/Fail Limit 22. TX Current Drain @ Levels 4-7

This sets the pass/fail limits for current used by the transmitter when the radio is enabled to transmit at RF output power levels 4-7. This pass/fail limit is used whenever the test set performs a system initialization prior to running a test when an external power supply is connected over HP-IB.

Pass/fail limits are determined by using any applicable pass/fail limit, such as:

- UUT Pass/fail Limit: Current Consumption, Transmit

For Example:

If your UUT pass/fail limit defines the transmitter's current consumption to be 2.7 Amps for RF output power levels 4-7, you might enter .5 as the Lower Limit and 2.7 as the Upper Limit.

Lower and Upper Limits must be entered in Amps.

It's Used in the Following Test:

[TEST_13. TX Current Drain](#)

Pass/Fail Limit 23. TX DTMF Frequency Error

This sets the pass/fail limits for the amount of frequency error allowable for the DTMF (Dual-Tone Multi-Frequency) signals.

For Example:

If your standard states that the seven tone frequencies in the high and low group DTMF signals should be within $\pm 1.5\%$ of their nominal values, you would enter **-1.5** as the Lower Limit and **1.5** as the Upper Limit.

Lower and Upper Limits must be entered in %.

It's Used in the Following Test:

TEST_28. TX DTMF Frequency Error

Pass/Fail Limit 24. TX FM Hum and Noise

This sets the pass/fail limits for the residual FM hum and noise measured from the radio.

Pass/fail limits are determined by using any applicable standard, such as:

- JTACS Standard: FM Hum and Noise

For Example:

If your standard states that FM hum and noise should be at least 26 dB below the level of a 1 kHz tone at ± 2.3 kHz deviation, you would enter **-26** as the Upper Limit.

Limits must be entered in dB.

It's Used in the Following Test:

[TEST_09. TX FM Hum and Noise](#)

Pass/Fail Limit 25. TX Frequency Error

This sets the pass/fail limits for the UUT's frequency stability.

Pass/fail limits are determined by using any applicable standard, such as:

- JTACS Standard: Frequency Tolerance; Frequency Error

For Example:

If your standard states that the carrier frequency should be maintained within ± 3 parts per million (ppm) of any assigned channel frequency, you would enter -3 as the Lower Limit and 3 as the Upper Limit.

Lower and Upper Limits must be entered in ppm.

It's Used in the Following Tests:

[TEST_03. TX Frequency Error](#)

[TEST_26. TX Switch Channels](#)

Pass/Fail Limit 26. TX NTACS Compressor Zero Reference Deviation

This sets the pass/fail limits that are used when the compressor's 0 dB reference deviation is measured on narrow voice channels. The 0 dB reference deviation is found when a voltage input (the 43. TX voltage for compressor zero crossing test parameter) to the transmitter produces an output at the transmitter equal to the specified peak frequency deviation.

Pass/fail limits are determined by using any applicable standard, such as:

- JTACS Standard: Compressor

For Example:

If your standard states that the voltage input to the transmitter is a -15 dBV rms 1 kHz tone which produces 1.5 kHz \pm 0.1 kHz peak frequency deviation of the carrier at the output of the transmitter, you would enter **1.4** as the Lower Limit and **1.6** as the Upper Limit.

Lower and Upper Limits must be entered in kHz.

It's Used in the Following Test:

[TEST_12. TX Compressor Response](#)

Pass/Fail Limit 27. TX NTACS DSAT Closure

This sets the pass/fail limits that are used when closure of the eye pattern is measured for DSAT transmitted by the UUT on a narrow voice channel.

Pass/fail limits are determined using any applicable standard, such as:

- NTACS Standard: Transmit Data Characteristics

For Example:

If your standard states that the eye pattern closure must be greater than 70%, you would enter 70 as the lower limit.

Limits must be entered in %.

It's Used in the Following Test:

TEST_10. TX SAT/DSAT

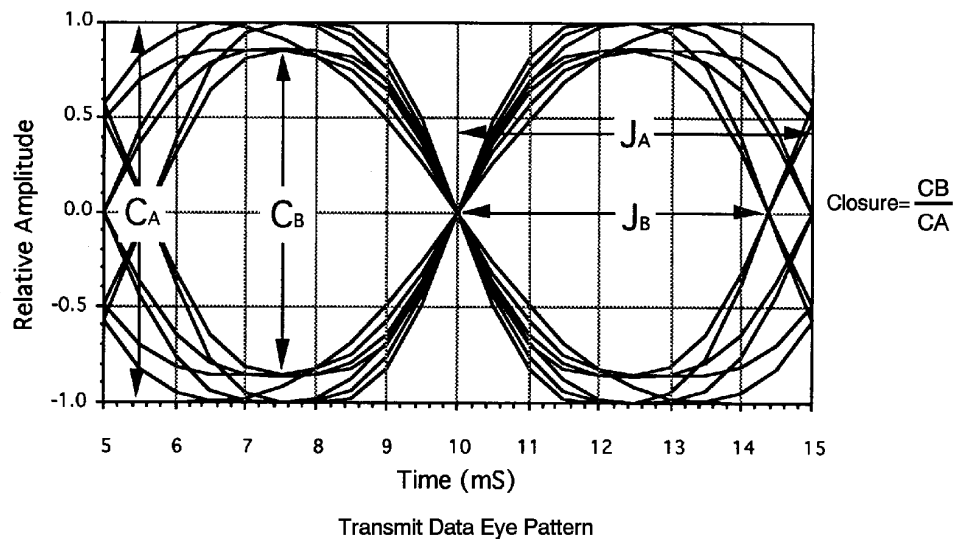

Pass/Fail Limit 28. TX NTACS DSAT Deviation

This sets the pass/fail limits that are used for peak frequency deviation measurements of the DSAT sequence transmitted by the UUT on a narrow voice channel.

Pass/fail limits are determined using any applicable standard, such as:

- NTACS Standard: Data Signals

For Example:

If your standard states that the peak frequency deviation for the DSAT sequence shall be ± 700 Hz with a ± 10 % tolerance, you would enter **630** as the lower limit and **770** as the upper limit.

Lower and upper limits must be entered in Hz.

It's Used in the Following Test:

- [TEST_10. TX SAT/DSAT](#)
- [TEST_11. TX RVC Data Deviation](#)

Pass/Fail Limit 29. TX NTACS DSAT Phase Jitter

This sets the pass/fail limits that are used when phase jitter of the eye pattern is measured for DSAT transmitted by the UUT on a narrow voice channel.

Pass/fail limits are determined using any applicable standard, such as:

- NTACS Standard: Transmit Data Characteristics

For Example:

If your standard states that the phase jitter of the eye pattern must be less than 10%, you would enter 10 as the upper limit.

Limits must be entered in %.

It's Used in the Following Test:

TEST_10. TX SAT/DSAT

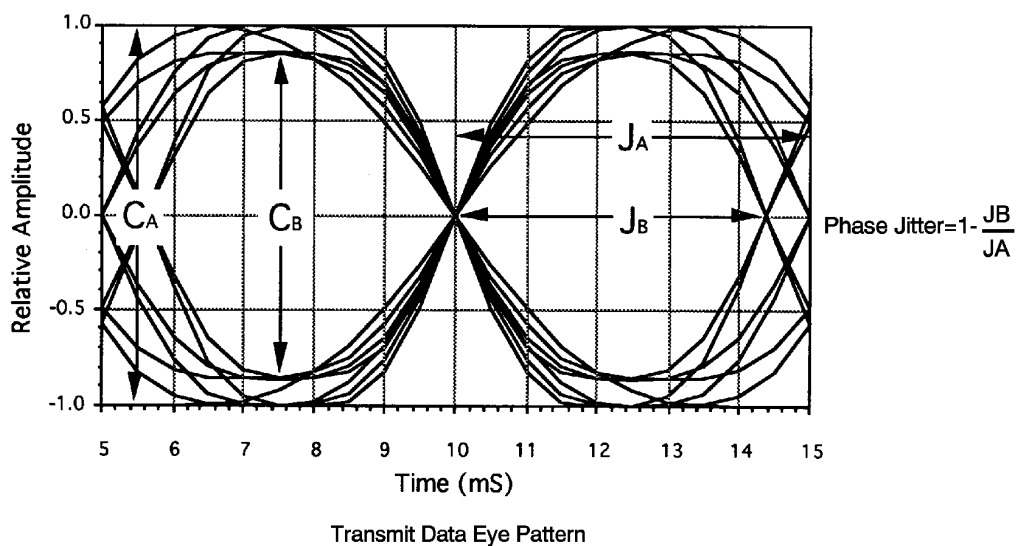

Pass/Fail Limit 30. TX NTACS Peak Frequency Deviation

This sets the pass/fail limits when the transmitter circuits are tested for their ability to prevent the transmitter from producing deviation in excess of the rated system deviation for narrow voice channels.

For Example:

If your standard states that the instantaneous peak and steady-state deviations of the transmitter should not exceed the rated system peak-frequency deviation of ± 5.0 kHz, you would enter **5.0** as the Upper Limit.

Limits must be entered in kHz.

It's Used in the Following Test:

[TEST_05. TX Peak Frequency Deviation](#)

Pass/Fail Limit 31. TX Peak Frequency Deviation

This sets the pass/fail limits when the transmitter circuits are tested for their ability to prevent the transmitter from producing deviation in excess of the rated system deviation for wide voice channels.

For Example:

If your standard states that the instantaneous peak and steady-state deviations of the transmitter should not exceed the rated system peak-frequency deviation of ± 9.5 kHz, you would enter **9.5** as the Upper Limit.

Limits must be entered in kHz.

It's Used in the Following Test:

TEST_05. TX Peak Frequency Deviation

Pass/Fail Limit 32. TX SAT Deviation

This sets the pass/fail limits for the Supervisory Audio Tone (SAT) deviation.

Pass/fail limits are determined by using any applicable standard, such as:

- JTACS Standard: Supervisory Audio Tone (SAT)

For Example:

If your standard states that the peak frequency deviation of each transponded SAT should be $\pm 1.7 \text{ kHz} \pm 10\%$, you would enter **1.53** as the Lower Limit and **1.87** as the Upper Limit.

Lower and Upper Limits must be entered in kHz.

It's Used in the Following Test:

[TEST_10. TX SAT/DSAT](#)

Pass/Fail Limit 33. TX SAT Frequency Error

This sets the pass/fail limits for frequency error allowable when the Supervisory Audio Tone (SAT) is tested.

Pass/fail limits are determined by using any applicable standard, such as:

- JTACS Standard: Supervisory Audio Tone (SAT)

For Example:

If your standard states that any one of the three SAT tones should not vary in frequency more than ± 1 Hz, you would enter **-1** as the Lower Limit and **1** as the Upper Limit.

Lower and Upper Limits must be entered in Hz.

It's Used in the Following Tests:

[TEST_10. TX SAT/DSAT](#)

[TEST_26. TX Switch Channels](#)

Pass/Fail Limit 34. TX Signaling Tone Deviation

This sets the pass/fail limits for the Signaling Tone deviation.

Pass/fail limits are determined by using any applicable standard, such as:

- JTACS Standard: Signaling Tone (ST)

For Example:

If your standard states that the nominal peak frequency deviation of the carrier produced by the Signaling Tone should be $\pm 6.4 \text{ kHz} \pm 10\%$, you would enter **5.76** as the Lower Limit and **7.04** as the Upper Limit.

Lower and Upper Limits must be entered in kHz.

It's Used in the Following Test:

[TEST_08. TX Signaling Tone/DST](#)

Pass/Fail Limit 35. TX Signaling Tone Frequency

This sets the pass/fail limits which are used when the Signaling Tone frequency is tested.

Pass/fail limits are determined by using any applicable standard, such as:

- JTACS Standard: Signaling Tone (ST)

For Example:

If your standard states that the Signaling Tone should be an 8 kHz \pm 1 Hz tone, you would enter **7.999** as the Lower Limit and **8.001** as the Upper Limit.

Lower and Upper Limits must be entered in kHz.

It's Used in the Following Test:

TEST_08. TX Signaling Tone/DST

Pass/Fail Limit 36. TX Wideband Data Deviation

This sets the pass/fail limits for the Wideband Data deviation.

Pass/fail limits are determined by using any applicable standard, such as:

- JTACS Standard: Wideband Data Signals; Modulation and Polarity.

For Example:

If your standard states that the Wideband Data frequency deviation should be ± 6.4 kHz with a $\pm 10\%$ tolerance, you would enter **5.76** as the Lower Limit and **7.04** as the Upper Limit.

Lower and Upper Limits must be entered in kHz.

It's Used in the Following Test:

[TEST_11. TX RVC Data Deviation](#)

Pass/Fail Limit 37. TXT Wideband Data Deviation Transient

This sets the pass/fail limits for the transient portion of the wideband data deviation measurement (TEST_11). This specification is only used if parameter 44 *TXT transient/ss data [0=tran 1=bth 2=ss]* is set to 1=bth (both), which causes the software to separately report the transient and steady state portions of the measurement.

It's Used in the Following Test:

TEST_11. TX RVC Data Deviation

5

Reference (Alphabetical)

This chapter provides detailed descriptions of the features and functions of the HP 11807A,E software. Topics are arranged alphabetically for quick, easy reference.

Conventions Used

Special presentations of text in this manual reflect the appearance of the item being referred to.

Examples of these special presentations are:

TESTS

A key on the test set.

Procedure:

Characters displayed on the CRT display.

k1 (**Run Test**)

A USER key, in the key column next to the CRT. Run Test is displayed on the CRT.

0.000000

A field on the CRT where entries can be made.

Titles of documentation are printed in italics.

The term test set refers to the HP 8920A,B,D.

In the steps in this manual the following words are used to describe cursor and entry actions

- **select** refers to pressing the knob after positioning the cursor in front of the appropriate field (**inverse video** area).
- **choose** means to position the cursor in front of an item in the **Choices:** or **To Screen** menu in the lower right corner of the CRT display, and then press the knob.
- **enter** means to use the numeric keypad, and the ENTER key or measurement units keys to make entries to fields. In some procedures, **enter** is used to describe the action of entering characters into a field.

Copying Files

Files can be copied from one mass-storage device to another using IBASIC COPY commands. For example, to copy a file from an inserted memory card to the left drive of an external dual-disk drive with HP-IB address 700, press TESTS. Select **IBASIC Cntrl** from the **SET UP TEST SET** list (or **IBASIC** from the **Test Function** field). Position the cursor to the IBASIC command line and select it. Using the character list that appears in the **Choices** menu, enter the following command:

```
COPY "MY_TEST:INTERNAL" TO "MYFILE:,700,0"
```

You can copy a file from a memory card to an SRAM memory card by loading the program from the memory card into the test set, inserting an initialized SRAM memory card, and then using the IBASIC SAVE command. Enter the following:

```
SAVE "MY_TEST:INTERNAL"
```

You can list the names of the files stored in a memory card or disk catalog by using the IBASIC CAT command. To display a list of file names on a memory card, enter the following:

```
CAT ":INTERNAL" or CAT
```

The mass storage powers-up to memory card as a default. If you did not change this setting, then **":INTERNAL"** is optional. If you are entering many characters into the IBASIC command line, you may want to connect a terminal to the test set. [See "Serial Port", "Operating Considerations" on page 248](#). You will also want to use a terminal if you have many files to list because file names displayed with the **CAT** IBASIC command scroll past the top of the test set's CRT display and cannot be scrolled down.

IBASIC is used when writing your own programs and is not explained in this manual. If you need to write your own IBASIC programs you may acquire the following manuals:

- HP 8920A,D
 - *HP Instrument Basic User's Handbook* HP part number E2083-90000.
 - *HP 8920A Programming Manual* HP part number 08920-90220.
- HP 8920B
 - *HP Instrument Basic User's Handbook Version 2.0* HP part number E2083-90005.
 - *HP 8920B Programming Manual* HP part number 08920-90222.

See also: "[Data Collection \(Saving and Retrieving Test Results\)](#)" on page 199; "[Initializing a Disk](#)" on page 209.

Data Collection (Saving and Retrieving Test Results)

The software has the capability to save test results to an SRAM memory card, to a disk drive, or to a PC.

Collection to a Memory Card or Disk

You will have to make entries into the **External Devices** (Edit Config) screen to describe the type of data collection you are using.

To configure External Devices entries:

1. Press TESTS
2. Select **External Devices** from the **SET UP TEST SET** list (or **Edit Cnfg** from the **Test Function** field).
3. Position the cursor to the **Calling Name** field and select it.
4. Using the list of characters in the **Choices** menu, enter **DATA C** into the **Calling Name** next to **Inst# 1**. The entry will look like:

```
1  DATA C
```

Note: For some SW revisions, DATA C will appear in the **Choices** menu. In this case, you may select DATA C, then Done instead of typing each character individually.

5. Position cursor to the **Addr** field and select it.
6. Using the DATA keypad, enter a number into **Addr**, depending on the type of storage media you will be using (press ENTER when complete):

If you are using a memory card, enter **1** into the **Addr**:

```
1  DATA C    1
```

If you are using a disk drive, enter the HP-IB disk address. For example, if the drive you are using is set to 700, then the display needs to look like:

```
1 DATA C 700
```

Calling names can be entered in any order.

The test software supports data storage on Logical Interchange Format (LIF) and Disk Operating System (DOS) disk formats. Storage can be to any of the following file types:

- ASCII files under LIF
- BDAT files under LIF
- HP-UX files under LIF
- DOS files under DOS

You will be specifying the file type with the entry you make into the **Options** field immediately below **DATA C**. If no file type is entered, and the disk format is LIF, the software will select an HP-UX file type. If no file type is entered, and the disk format is DOS, the software will select a DOS file type. For example, if you are using a DOS file and you are not using an extension on the file name, the entry on this screen will look like:

```
1 DATA C 700
```

If you are using an ASCII, BDAT or HP-UX file, you can specify the number of records allocated to the file. The DOS file is automatically updated as data is stored, so record allocation is not required. If you are using HP-UX files, you will have to enter **REC=** to establish a usable number of records. **REC=20480** sets the size to be the same as the default number of 256 byte records used for ASCII files (80 × 256). You can enter the **REC=** after the file type. For example, to use an ASCII file with 200 records of 256 bytes each, you will enter **ASCII REC=200** into the **Options** field.

NOTE: For some software revisions, **REC=** and **ASCII REC=** will appear in the **Choices** menu. In this case, you may select **REC=** or **ASCII REC=**, enter the number of records using the DATA keypad, then select **Done**, instead of typing in each character individually.

The display will appear as follows:

```
1 DATA C 700
  ASCII REC=200
```

The default number of records, used when no **REC=** entry is made, is 80.

Items in the **Options** field can be separated by a comma or a space.

See "**Initializing a Disk**" on page 209 if using a new disk. See "**Initializing a Memory Card**" on page 217 if using a new memory card. The file types under LIF can be used by the test set's IBASIC controller and some HP workstations. The DOS format is required if you wish to use the disk with a PC.

Table 8 Data Collection (Saving/Retrieving Tests) Configuration Summary

Inst#	Calling Name Options	Model	Addr	Description
1	DATA Collection	don't care	7xx ¹	To HP-IB disk drive
1	DATA Collection	don't care	1	To memory card
Options: ²	File types of ASCII, or BDAT, or (EXT), ³ or blank, ⁴ REC=xxxxx, (number of records)	don't care	7xx ¹	LIF format LIF format DOS file type DOS or HP-UX file type ⁴ Number of records
1	DATA Collection	don't care	9	Serial to external computer (laptop)

1. xx = Last two digits of HP-IB address.
2. These options apply to disk drive and memory card data collection. They do not apply when collecting data with Addr=9.
3. A DOS file name extension. For example, the file name may be CELL1.EXT.
4. DOS is used if the disk format is DOS. HP-UX is used if the disk format is LIF.

Retrieving Data from a Memory Card

To retrieve the test results after they have been saved on an SRAM memory card, you will have to run an IBASIC program. The following is a program to transfer data from a memory card to a terminal emulator. You can type the program lines into the IBASIC command line from a terminal emulator. See "[Configuration for Terminal or PC Operation](#)" on page 207.

To enter the data retrieval program:

1. Press TESTS.
2. Select **IBASIC Cntrl** from the **SET UP TEST SET** list (or **IBASIC** from the **Test Function** field).
3. Position the cursor to the IBASIC command field (large field in the upper part of the display) and select it. From the list of characters in the **Choices** field, enter the following IBASIC program statements and commands.
4. Enter **SCRATCH** to delete the previous IBASIC program. Be sure it's saved first.
5. Enter the following program:

```
10 DIM A$(120)
```

Sets the string length to 120.

```
20 ASSIGN @File TO "RES:INTERNAL";FORMAT ON
```

Opens a path to the memory card file called "RES" (for results).

```
30 ON ERROR GOTO 80
```

Exits at end of file if an error is encountered.

```
40 LOOP
```

Extracts file contents.

```
50 ENTER @File;A$
```

Transfers part of the file to the string.

```
60 OUTPUT 9;A$
```

The string is output at the Serial port.

```
70 END LOOP
```

Goes back to get more of the file.

```
80 END
```

End of the program.

6. Press k1 (**Run**) to run the entered IBASIC program.

***DIFFERENCE
BETWEEN RUN AND
RUN TEST***

The USER (**Run**) key, assigned as a default key on the TESTS (**IBASIC Controller**) screen, will start an IBASIC program that is resident in the test set's memory. The USER (**Run Test**) key, assigned as a default key on the TESTS screens, will load and run the program that is called from the **Select Procedure Filename:** and **Select Procedure Location:** entries on the TESTS **Main Menu** screen.

Collection to a PC

Test results can be output through the serial port. A variety of devices can receive the data. An HP Palmtop computer, PC, laptop, or terminal can be used. A terminal emulator can log the test results to a file. Examples of terminal emulator programs are HP AdvanceLink and ProComm, a product of DataStorm Technologies, Inc.

For example: Configuring an IBM-Compatible PC with HP AdvanceLink for DOS

1. Load and run HP AdvanceLink on your PC.
2. Use the following tables to set the *Global Configuration*, *Terminal Configuration*, and *Remote Configuration* settings.

Table 9 **Global Configuration Settings**

FIELD	SETTING	FIELD	SETTING
Keyboard	USASCII	Memory Size	32K
Personality	HP	Plotter I/F	None
Language	English	HP Mode	Yes
Terminal Mode	Alphanumeric	Video Type	<i>Select your display type</i>
Remote to	<i>enter PC's serial port #</i>	Forms Path	<i>Enter path if used</i>
Printer I/F	None	Screen Size	<i>Enter the size</i>

Table 10 Terminal Configuration Settings

FIELD	SETTING	FIELD	SETTING
Terminal ID	2392A	Esc Xfer(N)	YES
Local Echo	OFF	ASCII 8 Bits	YES
CapsLock	OFF	FldSeparator	US
Start Col	01	BlkTerminator	RS
Bell	ON	ReturnDef	CR
XmitFnctn(A)	NO	Copy	Fields
SPOW(B)	NO	Type Ahead	NO
InhEolWrp(C)	NO	ROW Size	80
Line/Page(D)	LINE	Host Prmpt Char	D1
InhHndShk(G)	NO	Horiz. Scroll. Incr.	08
Inh DC2(H)	NO	Large [+] Key	+

Table 11 Remote Configuration Settings

FIELD	SETTING	FIELD	SETTING
Baud Rate	4800	SR(CH)	LO
Parity/Data Bits	None/8	Recv Pace	None
Eng Ack	No	Xmit Pace	None
Asterisk	OFF	CS(CB)Xmit	NO
Chk Parity	NO		

To set up for data collection to a PC:

1. Press TESTS.
2. Select **External Devices** from the **SET UP TEST SET** list (or **Edit Cnfg** from the **Test Function** field).
3. Position the cursor to the **Calling Name** field and select it.
4. Using the list of characters in the **Choices** menu, enter **DATA C** (next to **Inst# 1**):

1 DATA C
5. Position the cursor to the **Addr** field and select it.
6. Using DATA keypad, enter **9** and press ENTER :

1 DATA C 9

Calling names can be entered in any order.

Configuration for Terminal or PC Operation

It is preferable to enter long strings of characters into fields using a terminal. The characteristics of the serial port, when used for instrument control from a terminal or terminal emulator, are determined by settings on the test set's I/O CONFIGURE screen.

Set the following:

- **Serial In** to **Inst**
- **IBASIC Echo** to **On**
- **Inst Echo** to **On**

Set the remaining configuration entries to match the settings of your terminal or PC program.

Equivalent Front-Panel Control Characters

The following table lists the terminal/computer keystrokes that equate to front-panel controls. *Each equivalent character must be preceded by the Escape key.*

For example, to remotely access the CONFIGURE screen, you type Esc, C on your terminal/computer. (Be sure to use upper-case C for this example.)

Alternate sequences for 5 commonly-used functions are also available. Hold down the Ctrl (control) key and select the corresponding key for the desired function. (Example: Ctrl/H moves the cursor to the left one space.)

ENTER - ^J or ^M

CANCEL - ^C

BACKSPACE - ^H

KNOB_TURN_CW - ^R

KNOB_TURN_CCW - ^L

Table 12 Equivalent Front-Panel Control Characters

Function	Equiv. ESC Char.	Function	Equiv. ESC Char	Function	Equiv. ESC Char
CANCEL	!	SAVE	G	PRESET	i
PERCENT MHZ_V	(REF_SET	J	INCR_DIV_10	j
S_KHZ_MV)	METER	K	INCR_SET	k
BACKSPACE	-	AVG	L	INCR_TIMES_10	l
ENTER	.	LO_LIMIT	M	DOWN	m
RELEASE	0	HI_LIMIT	N	UP	n
K1	1	E	R	SEVEN	o
K2	2	F	S	EIGHT	p
K3	3	B	U	NINE	q
K4	4	C	V	FOUR	r
K5	5	D	W	FIVE	s
K1_PRIME	6	A	X	SIX	t
K2_PRIME	7	EEX	Z	ONE	u
K3_PRIME	8	YES_ON_OFF	[TWO	v
ASSIGN	9	NO_PPM_W]	THREE	w
KNOB_TURN_CCW	<	RX	a	ZERO	x
KNOB_TURN_CW	>	TX	b	POINT	y
MSSG	A	DUPLEX	c	PLUS_MINUS	z
HELP	B	PREV	d	OHM_PCT_DEL_DBUV	{
CONFIG	C	TESTS_MAIN	e	DB_GHZ_DBM	
HOLD	D	LOCAL	f	MS_HZ_UV	}
PRINT	E	RECALL	g		
ADRS	F	MEAS_RESET	h		

Disks

Initializing a Disk

If you are starting with a blank disk, you will have to initialize it to the format you have chosen. Disk drives require specific commands to perform initialization. The test set's IBASIC commands to initialize some disks are described here. You should verify that the drive you are using can be controlled by the test set and that you are initializing a disk using a drive or PC that has a compatible format.

To initialize a disk to LIF in an HP-IB disk drive:

1. Verify that the test set **Mode** on the I/O CONFIGURE screen is set to **Control**:
 - a. Press TESTS.
 - b. Select **IBASIC Cntrl** from the **SET UP TEST SET** list (or **IBASIC** from the **Test Function** field).
 - c. Position the cursor to the IBASIC command field and select it.
 - d. With the list of characters in the **Choices** menu, enter the following:

```
INITIALIZE ":,7xx,y"
```

where:

xx = the HP-IB address of the disk drive, and
y = the unit number of the drive.

To initialize a disk to DOS in an HP-IB drive:

Follow the procedure for the LIF format, replacing the INITIALIZE statement with **INITIALIZE "DOS:,7xx,y"**.

Retrieving Data from a Disk

One way to retrieve the test results from a disk is to run an IBASIC program. A program to transfer data from a disk to a terminal emulator is given below. You can type it into the IBASIC command line from the terminal emulator.

Be sure your program is saved, because it will be deleted from programmable memory. The file name for this example is "RES". The disk address is 700, and the drive number is 0. The entire file name is **RES : , 700 , 0**.

To enter the data
retrieval program:

1. Press TESTS.
2. Select **IBASIC Cntrl** from the **SET UP TEST SET** list (or **IBASIC** from the **Test Function** field).
3. Position the cursor to the IBASIC command field (large field in the upper part of the display) and select it. From the list of characters in the **Choices** field, enter the following IBASIC program statements and commands.
4. Enter **SCRATCH** to delete the previous IBASIC program. Be sure it's saved first.
5. Enter the following program:

```
10 DIM A$(120)
```

Sets the string length to 120.

```
20 ASSIGN @File TO "RES:,700,0"
```

Opens a path to the file called "RES" (for results).

```
30 ON ERROR GOTO 80
```

Exits at end of file if an error is encountered.

```
40 LOOP
```

Extracts file contents.

```
50 ENTER @File;A$
```

Transfers part of the file to the string.

```
60 OUTPUT 9;A$
```

The string is output at the serial port.

```
70 END LOOP
```

Goes back to get more of the file.

```
80 END
```

End of the program.

6. Press k1 (**Run**) to run the entered IBASIC program.

Exiting a Program

Do not press RX or TX to exit the program. Selecting the RX TEST or TX TEST screen causes signal paths internal to the test set to be modified. If you exit the program to a screen other than RX TEST or TX TEST, the settings necessary to resume testing will be retained.

After you have made the manual settings you want, press the DUPLEX key as a last step before continuing the software. This will cause the test set to be properly set up.

Another way to safely exit is to:

1. Press CANCEL.
2. Press DUPLEX.
3. Press SHIFT SAVE.
4. Using list of characters in the **Choices** menu, enter a register name or number.
5. Select **Done**.
6. Operate the test set manually.
7. Press RECALL.
8. Choose the name of the saved setup.
9. Press TESTS.
10. Press k2 (**Continue**).

HP-IB Control Annunciators

The words, letters, and symbols at the top right corner of the CRT display indicate these conditions:

- **R** indicates remote operation from an external controller or IBASIC program in the test set. This letter will be displayed while the software is running.
- **L** indicates that the test set is listening, and is ready to receive a manual or remote command.
- **T** indicates that the test set is talking to another HP-IB device.
- **S** indicates that a service request has been generated.
- **C** indicates that the test set is currently an active controller. Control mode is set on the I/O CONFIGURE screen. The test set must be a controller if HP-IB peripherals are to be controlled.
- ***** indicates that an IBASIC program is running, or that the IBASIC controller is executing a command.
- **?** indicates that an IBASIC program is waiting for a user response.
- **-** indicates that the IBASIC program is paused.
- **SHIFT** indicates that the SHIFT key was pressed, and that the next key entry will be shifted. (Press SHIFT again to clear).

Memory Cards

Memory cards are inserted into the slot on the test set's front panel. The memory card is powered by the test set while it is inserted. Arrows printed on the memory card and the test set's front panel indicate the direction and orientation of card insertion.

Memory cards are used to store or retrieve the following:

- Software code
- An HP-supplied Procedure, containing:
 - A default TEST sequence
 - Default test parameter values
 - Default pass/fail limit values
- A Library file
- Procedures you make, optimized for your application
- Data collection files
- Channel Information
- User defined keys

Three types of memory cards are available:

- Static Random Access Memory (SRAM)
 - SRAM cards have read and write capability. SRAM cards can be programmed and read with the test set.
- One-Time Programmable (OTP)
 - Once programmed with a suitable card programmer, OTP cards have read-only capability. OTP cards can be read with the test set, but cannot be programmed with the test set.
- Flash Memory
 - Flash cards have read and write capability. They can only be written to, or programmed with a suitable card reader/programmer. Flash memory cards cannot be written to, or programmed with a test set. Flash memory cards can be read by the test set.

NOTE: Hewlett-Packard-supplied software code and Hewlett-Packard procedure and library files are typically supplied on either OTP cards or flash cards. Flash cards can be distinguished from OTP cards by a small write protect (WP) switch in the end of the flash cards. SRAM cards also have a write protect or safe switch in the end of the card, but they also use a battery. Software and procedure/library files stored on a flash card cannot be overwritten by a test set regardless of the position of the write protect (WP) switch.

NOTE: The software memory card can be removed after the program is loaded into the test set memory. The program will remain in memory after a power-down/power-up cycle, until a new program is loaded. Loading a new program will replace the existing program.

SRAM Memory Cards

A Static Random Access Memory (SRAM) Card can be used to store test results and procedures you make. The following parts can be used.

Table 13 SRAM Memory Card Products for HP 8920A,D

Memory	Product
32 kilobytes	HP 85700A
128 kilobytes	HP 85702A
256 kilobytes	HP 85704A
512 kilobytes	HP 85705A

Table 14 PCMCIA SRAM Memory Card Products for HP 8920B

Memory	Product
64 kilobytes	HP 83230A
256 kilobytes	HP 83233A
1 megabyte	HP 83231A

SRAM memory cards use a lithium battery (For HP 11807A: part number CR 2016 or HP part number 1420-0383. For HP 11807E: part number CR 2025 or HP part number 1420-0509). Programs and data will be retained for over one year if the memory card is stored at 25° C. The memory card is powered by the test set while it is inserted. Replace the battery while the memory card is inserted into a powered-up test set. To retain data and programs, it should be replaced annually. See the *HP 8920 User's Guide*. The write-protect switch on an SRAM memory card will write protect the card when it is set toward the outside of the card.

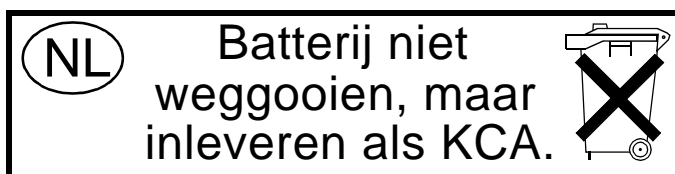

Memory Card Storage Space

Procedures use 12-16 records each. A Library uses 20-35 records. A single library must be included on the card. A record is 256 bytes. Approximately 11 kilobytes of overhead is required on each card.

Use the following formula to estimate the storage space needed:

$$\text{Storage Space (in kilobytes)} = (\text{Number of Procedures} \times 4.1) + 20$$

For example, if you want to save ten different procedures, you will need 61 kilobytes of memory. The 64 kilobyte or 128 kilobyte card is sufficient.

The storage space you need for data collection depends on the number of test results that are saved. You will need approximately 4 kilobytes per page of test results that you save. A page of test results is about 57 lines of CRT or printer output.

The storage space of smaller SRAM cards can be quickly used. If you are collecting large quantities of data, data collection using a PC or printer may be preferable.

Initializing a Memory Card

Initializing HP 11807A cards (Smart Cards) using the TESTS **Save/Delete Procedure** screen automatically defaults to LIF format. Initializing HP 11807E cards (PCMCIA) using the TESTS **Save/Delete Procedure** screen automatically defaults to DOS format. However, initializing cards from the **Save/Delete Procedure** screen is only available on HP 8920B or HP 8920A,D test sets with firmware above revision A.14.00. If these settings do not match your needs, or you have firmware below revision A.14.00, there is another method described below in which you may select the format.

- Press TESTS.
- Select **Save/Delete Procedure** from the **CUSTOMIZE TEST PROCEDURE** list.
- Insert the SRAM card in the slot on the front panel. (Make sure the switch on the card is not in the write-protected position).
- Press k3 (**Init Card**).
- Press Yes if you want to continue.

There are two ways to initialize a memory card to select the format. If you have a terminal emulator attached to the test set, you can type a command into the IBASIC command line. A second way to initialize a card is to run the ROM program RAM_MNG.

To initialize an SRAM card using IBASIC

1. Press TESTS.
2. Select **IBASIC Cntrl** from the **SET UP TEST SET** list (or **IBASIC** from the **Test Function** field).
3. Position the cursor to the IBASIC command line and select it.
4. Using the list of characters under the **Choices** menu, enter the following IBASIC command:

For LIF format: **INITIALIZE ":INTERNAL"**

For DOS format: **INITIALIZE "DOS:INTERNAL"**

To initialize an SRAM card using RAM_MNG

1. Press TESTS.
2. Position the cursor to the **Select Procedure Location** (or **Location**) field and select it.
3. From the **Choices** menu, select **ROM**.
4. Position the cursor to the **Select Procedure Filename** (or **Procedure**) field and select it.
5. From the **Choices** menu, select **IB_UTIL** (or **RAM_MNG**).
6. Press k1 (**Run Test**).
7. Follow the displayed instructions.

NOTE: Loading RAM_MNG will delete any procedure or program in memory.

Retrieving Data from a Memory Card

To retrieve the test results after they have been saved on an SRAM memory card, you will have to run an IBASIC program. The following is program to transfer data from a memory card to a terminal emulator. You can type the program lines into the IBASIC command line from a terminal emulator. See "[Configuration for Terminal or PC Operation](#)" on page 207.

To enter the data retrieval program:

1. Press TESTS.
2. Select **IBASIC Cntrl** from the **SET UP TEST SET** list (or **IBASIC** from the **Test Function** field).
3. Position the cursor to the IBASIC command field (large field in the upper part of the display) and select it. From the list of characters in the **Choices** field, enter the following IBASIC program statements and commands.
4. Enter **SCRATCH** to delete the previous IBASIC program. Be sure it's saved first.
5. Enter the following program:

```
10 DIM A$(120)
```

Sets the string length to 120.

```
20 ASSIGN @File TO "RES:INTERNAL";FORMAT ON
```

Opens a path to the memory card file called "RES" (for results).

```
30 ON ERROR GOTO 80
```

Exits at end of file if an error is encountered.

```
40 LOOP
```

Extracts file contents.

```
50 ENTER @File;A$
```

Transfers part of the file to the string.

```
60 OUTPUT 9;A$
```

The string is output at the serial port.

```
70 END LOOP
```

Goes back to get more of the file.

```
80 END
```

End of the program.

6. Press k1 (**Run**) to run the entered IBASIC program.

***DIFFERENCE
BETWEEN RUN AND
RUN TEST***

The USER (**Run**) key, assigned as a default key on the TESTS (**IBASIC Controller**) screen, will start an IBASIC program that is resident in the test set's memory. The USER (**Run Test**) key, assigned as a default key on the other TESTS screens, will load and run the program that is called from the **Select Procedure Filename** and **Select Procedure Location** entries on the TESTS **Main Menu** screen.

Parameters

Parameters are values you enter that optimize your use of the test software. Many of the parameters are determined by examining your test needs.

Default values are set into the software. Some of these values are derived from standard methods of measurement and some are derived from the industry standard requirements. Load a Procedure and select the **Test Parameters** screen from the **CUSTOMIZE TEST PROCEDURE** list, to see the default values.

You should verify that parameters are properly set after you select the tests to be placed in your procedure.

Parameters remain in battery-backed-up memory until you select a procedure to run. If you wish to prevent them from being lost when a new procedure is selected, you will have to save them in a procedure. See ["Saving a Procedure" on page 240](#).

To print the parameters list, see ["To print TESTS screens:" on page 233](#).

To edit a parameter value:

1. Press TESTS.
2. Select **Test Parameters** from the **CUSTOMIZE TEST PROCEDURE** list (or **Edit Parm** from the **Test Function** field).
3. Position the cursor to the **Parm#** field and select it.
4. Rotate the knob to the desired parameter number and select it.
5. Position the cursor to the **Value** field and select it.
6. Enter the desired value using the DATA keypad and press ENTER.
 - a. Use the ← key to backspace.
 - b. Press CANCEL to cancel entries and retain the old value.
7. Press k5 (**Main Menu**) (or TESTS) to return to the TESTS screen.

Pass/Fail Limits (specifications)

Pass/Fail Limits are values you enter that set passing limits for tests. Default values are available in the test software. They have been derived from standard methods of measurement.

Pass/Fail Limits do not have to be changed when you select a test or change the tests in your procedure. Each test has pass/fail limits that apply to it.

You should verify that pass/fail limits are properly set after you select the tests to be placed in your procedure. Lists of the pass/fail limits used by each of the tests are contained in the test descriptions in chapter 3 of this manual. A lock is provided to prevent access to the pass/fail limits. See "[Securing a Procedure](#)" on [page 244](#).

Pass/fail limits remain in the test set's battery-backed-up memory until you select a procedure to run. If you wish to prevent pass/fail limits from being lost when a new procedure is selected, you will have to save them in a procedure. See "[Saving a Procedure](#)" on [page 240](#).

To print the pass/fail limits list, see "[To print TESTS screens:](#)" on [page 233](#).

**To edit a pass/fail
limit value:**

1. Press TESTS.
2. Select **Pass/Fail Limits** from the **CUSTOMIZE TEST SET** list (or **Edit Spec** from the **Test Function** field).
3. Position the cursor to the **Spec#** field and select it.
4. Rotate the knob to the desired pass/fail limit number and select it.
5. Position the cursor to the **Lower Limit** or the **Upper Limit** field and select it.
6. Enter desired value using the DATA keypad and press ENTER.
 - a. Use the ← key to backspace.
 - b. Press CANCEL to cancel entries and retain the old value.
7. Position the cursor to the **Check** field and select it.
8. From the **Choices** menu, select the combination of upper and lower limits to be checked.

Pausing or Stopping a TEST

To pause the program, press CANCEL.

To stop the program, press SHIFT then CANCEL. This performs an IBASIC RESET operation.

CHANGING SETTINGS WHILE PAUSED

If you make changes to instrument settings while the program is paused, subsequent operation may be unpredictable. Error messages may or may not be displayed. See "[Exiting a Program](#)" on page 212.

To continue a paused program:

1. Press TESTS.
2. Press K1 (**Continue**).

The test time is displayed when the test is completed. This time includes the time that the program is paused and the time that it is waiting for connection and inputs to be made. If you are testing through midnight, the test time will not display properly.

Printing

You can print any of the following:

- Test results
- TESTS screens
 - "External Devices" (Edit Cnfg)
 - "Order of Tests" (Edit Seqn)
 - "Channel Information" (Edit Freq)
 - "Pass/Fail Limits" (Edit Spec)
 - "Test Parameters" (Edit Parm)

How to Print (task list) There are five basic steps to printing listed below. A detailed description of each of these steps is at the end of this section. **"Supported Printers" on page 225.**

1. Check to see if your printer is supported by the test set (see **"Supported Printers" on page 225**).
2. Determine if your printer requires serial, parallel, or HP-IB connection. Connect the printer to the appropriate port on the test set (see **"Printer Connection" on page 226**).
3. Configure the test set for your printer and its interface (see **"Configuring the Test Set for Printing" on page 228**).
4. Instruct the test set what to print (see **"To print test results" on page 235**).

Supported Printers

- HP ThinkJet printer
- HP QuietJet printer
- HP PaintJet printer
- HP DeskJet printer
- HP LaserJet printer
- Epson FX-80 printer
- Epson LQ-850 printer

If you do not have one of these printers, consult your printer's manual for the correct printer settings to emulate one of the supported printers.

Printer Connection

HP-IB Connection

An HP-IB printer can be connected to the test set's rear-panel HP-IB connector with an HP-IB cable.

Serial Connection

A serial printer can be attached to the serial port. See [figure 1 on page 226](#). Use the following RJ-11 pins for this connection.

- RJ-11 Pin 2 - test set Receive Data
- RJ-11 Pin 4 - Ground
- RJ-11 Pin 5 - test set Transmit Data

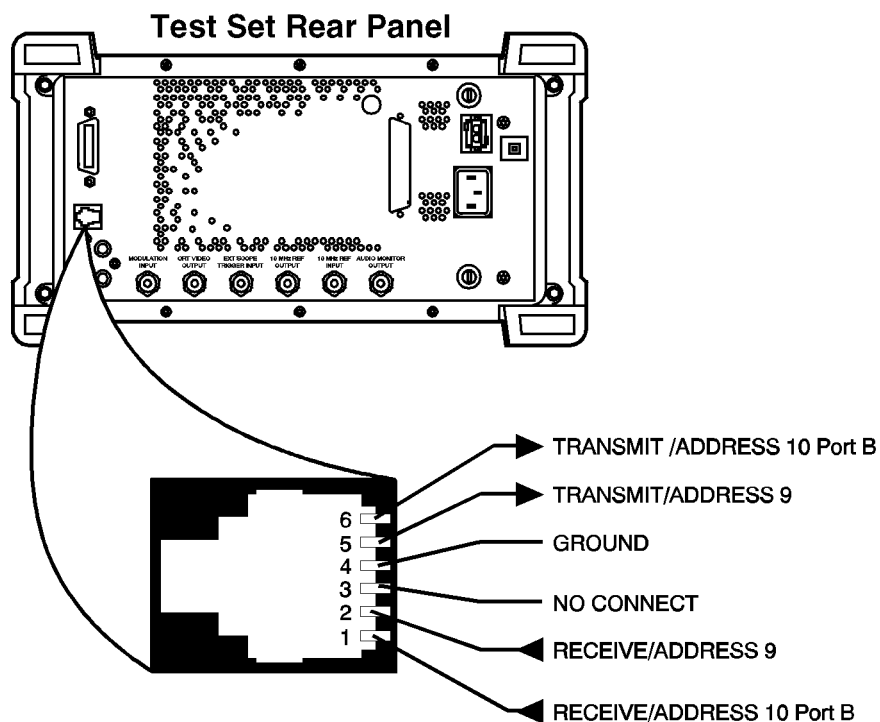

Figure 1 Test Set RJ-11 Serial Port Connections

Parallel Connection

A parallel printer can be attached to the parallel port. Use the following **figure 2** for pin information.

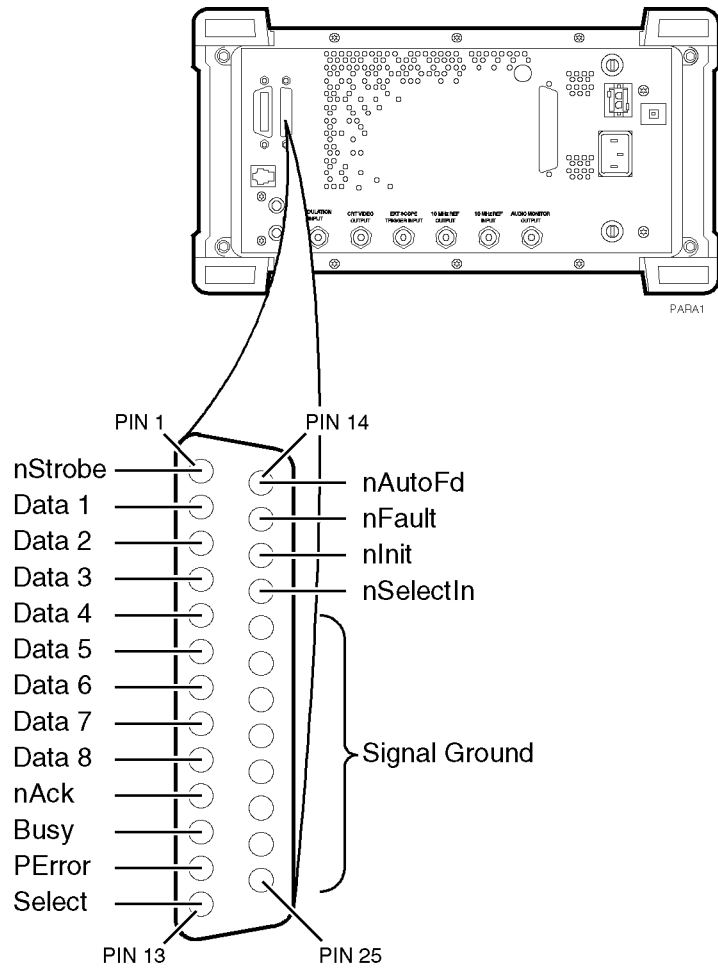

Figure 2 Test Set Parallel Port Connections

Configuring the Test Set for Printing

If using a serial printer, you cannot use the serial port for other connections at the same time, such as Data Collection (saving test results). Serial port connections are shown earlier in this section.

PRINTER SETUP DIFFERENCES

The HP 8920A,D had several firmware enhancements, which are standard in the HP 8920B. The following **Setup Printer** section applies to users with:

- HP 8920A,D test sets with firmware above revision A.14.00.
- All HP 8920B test sets.

The test set's firmware revision is displayed on the top right corner of the configuration screen.

- Press SHIFT CONFIG to display the configuration screen and read the firmware revision.

If you have an HP 8920A with firmware revision below A.14.00, refer to the next section, titled "To Setup Printer Using HP 8920A FW Below Rev. A.14.00". Contact Hewlett-Packard at 1-800-922-8920 for details on upgrading your firmware if desired.

EXCEPTION: If you are using A.xx.xx revision software, you can not use the Printer Setup screen regardless of your firmware revision. Refer to the instructions for firmware below A.14.00.

To Setup Printer Using Any HP 8920B Or HP 8920A FW Above Rev A.14.00

1. Press TESTS
2. Select **Printer Setup** from the **SET UP TEST SET** list.
3. Position the cursor to **Model** and select the desired printer.
4. Position the cursor to **Print Port** and select the desired port.
5. (If HP-IB only) Position the cursor to **Printer Adrs** and enter the HP-IB address for your printer (0-30).
6. Set the following options if desired:
 - a. Lines/Page (controls the number of lines, 20-120, printed on a page before a form feed is sent to the printer)
 - b. FF at Start (to cause a form feed at the start of a test sequence)
 - c. FF at End (to cause a form feed at the end of a test sequence)
7. From the **To Screen** menu, select **More**.
8. From the **Choices** menu, select **IO CONFIG**.
 - a. For Serial Printing, set the **Serial Baud** field and other serial communications fields listed under it to correspond to your printer's configuration.
 - b. For HP-IB Printing, set the **Mode** field to **Control**.
9. Press TESTS to return to the TESTS (**Main Menu**) screen.

To print test results:

1. Press TESTS
2. Select **Printer Setup** from the **SET UP TEST SET** list.
3. Position the cursor to **Output Results To** and select **Printer**.
4. Position the cursor to **Output Results For** and select **All** if you want all results printed, or **Failures** if you want failures only printed.
5. (Optional) Position the cursor to **Output Heading** and enter your desired heading.

To send Escape Sequences to the printer

If you have revision B.xx.xx software, you may use the test set to send escape sequences to control printer options such as pitch, margins, paper size, and so forth. The software comes with some pre-defined escape sequences compatible with HP printers, listed below, or you have the option to enter others which are compatible with your printer (use your printer's user's manual for the available print features and corresponding escape sequences). This function is not available with revision A.xx.xx software.

The software already has an implied escape character for the first sequence, you need only to enter the escape sequence following the escape character. However, if you are linking two or more sequences together, you must use the ~ to indicate the escape character between each sequence. If the sequence exceeds the space allotted in the options field, you may continue with additional escape sequences in the next available **Options** field. You must however, still enter **Escape Seq** in the **Calling Name** field and the appropriate address in the **Addr** field for all subsequent entries.

**How to send an
Escape Sequence:**

1. Press TESTS.
2. Select **External Devices** from the **SET UP TEST SET** list.
3. Position the cursor to the **Inst#** field and select it.
4. Rotate the knob until an empty **Calling Name** field appears, and select it.
5. Position the cursor to the **Calling Name** field and select it.
6. Select **Escape Seq** from the **Choices** menu.
7. Position the cursor to the **Addr** (address) field and select it.
8. Using the DATA keypad, enter **9** for serial printers, **15** for parallel printers, or **70X** for HP-IB printers, then press ENTER.
9. Position the cursor to the **Options** field (directly under **Calling Name**) and select it.
10. Select the desired escape sequence from the **Choices** menu if applicable, or enter an appropriate sequence using the list of characters below the choices.

Table 15 **Escape Sequence Definitions for HP Printers**

Escape Sequence	Print Feature
&l66P	Sets page length to 66 lines
&l72P	Sets page length to 72 lines
&l6D	Sets lines per inch to 6 lines
&l8D	Sets lines to inch to 8 lines
(s12h12v6T	Selects 12 characters per inch 12/72 inch character height gothic typeface
&a9L~&l6E	Sets left margin to 9 characters top margin to 6 lines
(s12h12v6T~&a9L~&l6E	Selects 12 characters per inch 12/72 inch character height gothic typeface left margin to 9 characters top margin to 6 lines
&l8d88P	Selects 8 lines per inch 88 lines per page
&l8d96P	Selects 8 lines per inch 96 lines per page
(s16.67h12V~&a17L~&l6E	Selects 16.67 characters per inch 12/72 inch character height left margin to 17 characters top margin to 6 lines

To print TESTS screens:

TESTS screens include:

- "External Devices"
- "Order of Tests"
- "Channel Information"
- "Pass/Fail Limits"
- "Test Parameters"

The same general process is used to print the information for all of the above TESTS screens.

1. Make sure that your printer is properly connected and configured as explained earlier in this section.
2. Press TESTS.
3. Select the **CUSTOMIZE TEST PROCEDURE** screen of your choice.
4. Press k3 (**Print All**) and select it.
5. Press TESTS to return to the TESTS (**Main Menu**) screen.

To Setup Printer Using HP 8920A FW Below Rev A.14.00

1. Press TESTS
2. Select **Edit Cnfg** from the **Test Function** field.
3. Position the cursor to the **Inst#** field and select it.
4. Rotate the knob until an empty **Calling Name** field appears, and select it.
5. Position the cursor to the **Calling Name** field and select it.
6. Using the list of characters in the **Choices** menu, enter the word **Printer**. Select **Done** when complete.
7. Position the cursor to the **Model** field and select it (optional).
8. Using the DATA keypad, enter the Model # and press ENTER.
9. Position the cursor to the **Addr** (address) field and select it.
10. Using the DATA keypad, enter **9** for serial printers, **15** for parallel printers, or **70X** for HP-IB printers, then press ENTER. .
11. Position the cursor to the **Options** field (directly under **Calling Name**) and select it.
12. Using the list of characters from the **Choices** menu, the following commands may be entered. Separate the commands with commas (example; **LN=60 ,START ,END**)
 - a. **LN** equals the number of printed lines per page.
 - b. **START** causes a form feed at the start of each printout.
 - c. **END** causes a form feed at the end of each printout.
13. From the **To Screen** menu, select **More**.
14. From the **Choices** menu, select **IO CONFIG**.
15. For Serial Printers:
 - a. Set the **Serial Baud** field and other serial communications fields listed under it to correspond to your printer's configuration.
16. For HP-IB Printers:
 - a. Position the cursor to the **Mode** field and select it.
 - b. From the **Choices** menu, select **Control**.
 - c. Position the cursor to the **Print Adrs** field and select it.
 - d. Rotate the knob and select the HP-IB address of your printer.
 - e. Position the cursor to the **Print To** field. Pressing knob will toggle the underlined selection. Select to underline **HP-IB**.
17. Press TESTS to return to the TESTS screen.

To print test results

1. Make sure that your printer is properly connected and configured as explained earlier in this section.
2. Press TESTS.
3. Position the cursor to the **Output Results To:** field (or the **Output Destination** field). Pressing knob will toggle the underlined selection. Select to underline **Printer**.
4. Position the cursor to the **Output Heading** field and select it.
5. Using the list of characters in the **Choices** menu, enter a printout heading (optional). Select **Done** when the heading is complete.

To send Escape Sequences to the printer

If you have revision B.xx.xx software, you may use the test set to send escape sequences to control printer options such as pitch, margins, paper size, and so forth. You may enter sequences which are compatible with your printer (use your printer's user's manual for the available print features and corresponding escape sequences). This function is not available with revision A.xx.xx software.

The software already has an implied escape character for the first sequence, you need only to enter the escape sequence following the escape character. However, if you are linking two or more sequences together, you must use the ~ to indicate the escape character between each sequence. If the sequence exceeds the space allotted in the options field, you may continue with additional escape sequences in the next available **Options** field. You must however, still enter **Escape Seq** in the **Calling Name** field and the appropriate address in the **Addr** field for all subsequent entries.

**How to send an
Escape Sequence:**

1. Press TESTS.
2. Select **Edit Cnfg** from the **Test Function** field.
3. Position the cursor to the **Inst#** field and select it.
4. Rotate the knob until an empty **Calling Name** field appears, and select it.
5. Position the cursor to the **Calling Name** field and select it.
6. Enter **ESCAPE SEQ** using the characters in the **Choices** menu. Select **Done** when you are finished.
7. Position the cursor to the **Addr** (address) field and select it.
8. Using the DATA keypad, enter **9** for serial printers, **15** for parallel printers, or **70X** for HP-IB printers, then press ENTER. .
9. Position the cursor to the **Options** field (directly under **Calling Name**) and select it.
10. Select the desired sequence using the list of characters below the choices.

Table 16 **Examples of Common Escape Sequences**

Escape Sequence	Print Feature
&l66P	Sets page length to 66 lines
&l72P	Sets page length to 72 lines
&l6D	Sets lines per inch to 6 lines
&l8D	Sets lines to inch to 8 lines
(s12h12v6T	Selects 12 characters per inch 12/72 inch character height gothic typeface
&a9L~&l6E	Sets left margin to 9 characters top margin to 6 lines
(s12h12v6T~&a9L~&l6E	Selects 12 characters per inch 12/72 inch character height gothic typeface left margin to 9 characters top margin to 6 lines
&l8d88P	Selects 8 lines per inch 88 lines per page
&l8d96P	Selects 8 lines per inch 96 lines per page
(s16.67h12V~&a17L~&l6E	Selects 16.67 characters per inch 12/72 inch character height left margin to 17 characters top margin to 6 lines

To print TESTS screens

TESTS screens include:

- "Edit Cnfg"
- "Edit Seqn"
- "Edit Freq"
- "Edit Spec"
- "Edit Parm"

The same general process is used to print the information for all of the above TESTS screens.

1. Make sure that your printer is properly connected and configured as explained earlier in this section.
2. Press TESTS.
3. Select the TESTS screen you desire.
4. Press k3 (**Print All**) and select it.
5. Press TESTS to return to the TESTS screen.

Procedures

A procedure is a collection of test parameters, pass/fail limits and a testing order, saved in a file that customizes the test software to a specific application. You may save the file on a memory card or disk.

You do not have to save a test sequence in a procedure. Each test can be stand-alone if desired. After you choose a procedure, you can choose which of the tests you want to run.

When you save a procedure you will only be saving test parameters, pass/fail limits and a testing order. The memory card or disk must also contain a library file. A library file contains the names of all of the test parameters, pass/fail limits and tests that are in the test software. The library you use will be the library that is supplied with your software. When you save your procedure, the library will be automatically saved on the same card or disk.

The procedure(s) supplied with your software will be listed in the **Choices:** column when you select the **Select Procedure Filename:** (or **Procedure**) field. Procedures will be displayed if your software memory card is plugged in.

Saving a Procedure

After you have set up the test software you can save the setup to an SRAM memory card, disk, or internal RAM memory by doing the following.

The memory card or disk you use must be initialized before its first use. See ["Initializing a Memory Card" on page 217](#) or ["Initializing a Disk" on page 209](#). If you are using a disk drive, you may have to enter the **External Disk Specification** into the **TESTS External Devices** screen (or **Edit Cnfg** screen). It will be used when the **Select Procedure Location:** field on the **TESTS** screen is **Disk**.

- To save a procedure:
1. Press TESTS.
 2. Select **Save/Delete Procedure** from the **CUSTOMIZE TEST PROCEDURE** list (or **Proc Mngr** from the **Test Function** field).
 3. Position the cursor to the **Select Procedure Location** (or **Location**) field and select it.
 4. From the **Choices** menu, select the desired location. The media must be initialized before a file can be saved. To initialize an SRAM card (HP 8920B or HP 8920A,D firmware above revision A.14.00 only, otherwise see "[Initializing a Memory Card](#)" on page 217):
 - Insert card in the slot on the test set's front panel.
 - Press k3 (**Init Card**)
 - Press **Yes**. Note: this will delete any procedures or programs from memory.

To initialize a RAM disk, see *Memory Cards/Mass Storage* in the *HP 8920 Programmer's Guide*.
 5. Position the cursor to the **Enter Procedure Filename** (or **Procedure**) field and select it.
 6. From the list of characters in the **Choices** menu, enter a filename. Filename must be nine characters or less. When filename is complete, position cursor to **Done** and select it. Procedure filenames that already exist on the card will appear at the top of the list of characters.
 7. If you selected **Card**, insert an initialized memory card into the slot on the test set's front-panel.
 8. Verify that the card or other media is not write-protected. See "[Memory Cards](#)" on page 214.
 9. Position the cursor to the **Enter Description for New Procedure** (or **Comment for new procedure**) field and select it. From the list of characters in the **Choices** menu, enter comments. When the comments are complete, position the cursor to **Done** and select it.
 10. Position the cursor to the **Procedure Library** (or **Library for new procedure**) field and select **Current** (Current underlined). The name of the Library is displayed on the TESTS screen.

11. Position the cursor to the **Code Location** (or **Program location for new procedure**) field and select it.

From the **Choices** menu, choose memory **Card, ROM, RAM** or **Disk**. When a procedure is run, the test system will look in this location for a code file if it is not resident in the Test Set's battery-backed-up memory. This location will usually be the software memory card.

12. Press k1 (**Save Proc**) (or position the cursor to the **Action** field and select **Make Procedure**). A procedure will be saved at the location you chose.

Loading a Procedure

A procedure can be loaded from storage media into the test set's battery-backed-up memory by doing the following.

- To load a procedure:**
1. Press TESTS.
 2. Position the cursor to the **Select Procedure Location** (or **Location**) field and select it.
 3. From the **Choices** menu, choose the desired location where the procedure is stored and select: **Card, ROM, RAM** or **Disk**.
 4. Position the cursor to the **Select Procedure Filename** (or **Procedure**) field and select it.
 5. From the **Choices** menu, choose the procedure file that you want to load.
 6. Read the **Description** (or **Comment**) field to ensure that the loaded procedure file is the one you want.

Deleting a Procedure

Procedures can be removed from an SRAM memory card, disk or RAM by doing the following.

To delete a Procedure:

1. Press TESTS.
2. Select **Save/Delete Procedure** from the **CUSTOMIZE TEST PROCEDURE** list (or **Proc Mngr** from the **Test Function** field).
3. Position the cursor to the **Select Procedure Location** (or **Location**) field and select it.
4. From the **Choices** menu, select the desired location.
5. Position the cursor to the **Enter Procedure Filename** (or **Procedure**) field and select it.
6. From the **Choices** menu, select the name of the procedure you wish to delete.
7. Press k2 (**Del Proc**) (or position the cursor to the **Action** field and select **Delete Procedure**).
8. Press Yes if you wish to continue.

Securing a Procedure

After you have set up your test software with a testing order, channel information, test parameters, and pass/fail limits, you may wish to secure it. This operation will prevent the viewing and changing of those functions. You can select the items you wish to secure or un-secure. An IBASIC ROM program is stored in the Test Set's firmware to do this.

You can secure the procedure that is supplied with the test software. It is shipped un-secured.

After you make a procedure, you can secure it.

To secure a Procedure:

1. Press TESTS.
2. Position the cursor to the **Select Procedure Location** (or **Location**) field and select it.
3. From the **Choices** menu, select **ROM**.
4. Position the cursor to the **Select Procedure Filename** (or **Procedure**) field and select it.
5. From the **Choices** menu, select **IB_UTIL** (or **SECURE_IT**).
6. Press k1 (**Run Test**).
7. Select the location of the procedure you want to secure: k1 memory (**Card**) or k2 (**RAM**).

NOTE:

RAM refers to the RAM Disk memory within the test set. Before selecting RAM, you must initialize the RAM as a disk. See ["RAM"](#), ["Initializing RAM Disks"](#) on page 246.

8. Proceed with the on-line instructions. You may wish to secure only one of the items, such as pass/fail limits.
9. When you are prompted to enter the **pass number**, enter any sequence of numerals 0 through 9 using the DATA keypad. Enter 9 digits or less.

To un-secure a procedure:

To un-secure a procedure, you must know the **pass number**.

1. Press TESTS.
2. Position the cursor to the **Select Procedure Location** (or **Location**) field and select it.
3. From the **Choices** menu, select **ROM**.
4. Position the cursor to the **Select Procedure Filename** (or **Procedure**) field and select it.
5. From the **Choices** menu, select **IB_UTIL** (or **SECURE_IT**).
6. Press k1 (**Run Test**).
7. Select the location of the procedure you want to un-secure: k1 memory (**Card**) or k2 (**RAM**).
8. Enter the name of the procedure you wish to un-secure.
9. If the procedure has any item secured, you will be asked for the **pass number**.
10. Proceed with the on-line instructions. Select the items you wish to un-secure.
11. When you are prompted, enter the **pass number** using the DATA keypad.

RAM

RAM disk is a section of internal memory that acts much like a flexible disk. Programs can be stored, re-stored, erased, and retrieved.

The RAM disk is partitioned into four separate volumes; 0-3. Each volume is treated as a separate 'disk'. You can also specify the size of each disk in 256-byte increments.

The four RAM disk volumes are designated **:MEMORY,0,0** to **:MEMORY,0,3**. For example, to catalogue the contents of RAM disk volume '0' from the **IBASIC Cntrl** screen, enter

```
CAT ":MEMORY,0,0"
```

Volume 0's contents can be viewed and loaded from the three screens mentioned at the beginning of this section. Volumes 1, 2, and 3 can *only* be accessed from the **IBASIC Controller**.

RAM DISK ERASURE Any existing programs or formatting on RAM is erased if you use the **RAM_MNG** or **COPY_PL** ROM programs, or the **SERVICE** screen's **RAM Initialize** function.

Therefore, you should only use RAM disks for short-term storage of files.

Initializing RAM Disks

Each RAM disk volume must be initialized before it can be used. Volume 0 can be initialized using the **RAM_MNG** procedure stored on the internal ROM's **IB_UTIL** menu. Volumes 1, 2, and 3 must be initialized from the **IBASIC Cntrl** screen.

The optional 'volume size' in the following procedure lets you specify the memory area set aside for each disk in 256 byte blocks.

Follow these steps to initialize volumes 1, 2, or 3:

1. Press **TESTS**.
2. Select **IBASIC Cntrl** from the **SET UP TEST SET** list.
3. Position the cursor to the data entry field and select it.
4. Using the list of characters from the **Choices** menu, enter the following command:

```
INITIALIZE ":MEMORY,0,<volume number 1-3>",<volume size>
OR
INITIALIZE ":MEMORY,0,1",50
```

Saving Tests Results

See "[Data Collection \(Saving and Retrieving Test Results\)](#)" on page 199.

Serial Port

This 6-pin, RJ-11 serial port is used to input and output serial data. Serial data is used for entering programs, printing, and for sending test results to a connected controller, disk drive, or terminal.

Operating Considerations

The serial communications settings are defined on the I/O CONFIGURE screen. Ground is used with both IBASIC and all other serial connections. Transmit B and Receive B are exclusively used with IBASIC programs. Transmit and Receive are used with all other serial connections (see [figure 3](#)).

The IBASIC Controller sends data to and receives data from the serial ports using address **9** for the primary port, and address **10** for Port B.

Use an RJ-11/25-pin RS-232 adapter (HP P/N 98642-66508) and RJ-11 cable (HP P/N 98642-66505) to connect the HP 8920A,B,D to a serial printer or terminal/computer.

RJ-11 CONNECTORS RJ-11 cables and adapters can be wired several ways. If you buy a cable or adapter other than the HP parts listed, verify the connections for the pins indicated in the following table before connecting cables to the instruments.

The following table lists connections for Transmit, Receive, and Ground pins (address 9).

Table 17 Examples of Common Escape Sequences

HP 8920A/D RJ-11 Serial Port		Terminal/PC 25-Pin RS-232		Terminal/PC 9-Pin RS-232
Pin 2 (RX)	to	pin 2 (TX)	or	pin 3 (TX)
Pin 5 (TX)	to	pin 3 (RX)	or	pin 2 (RX)
Pin 4 (GND)	to	pin 7 (GND)	or	pin 5 (GND)

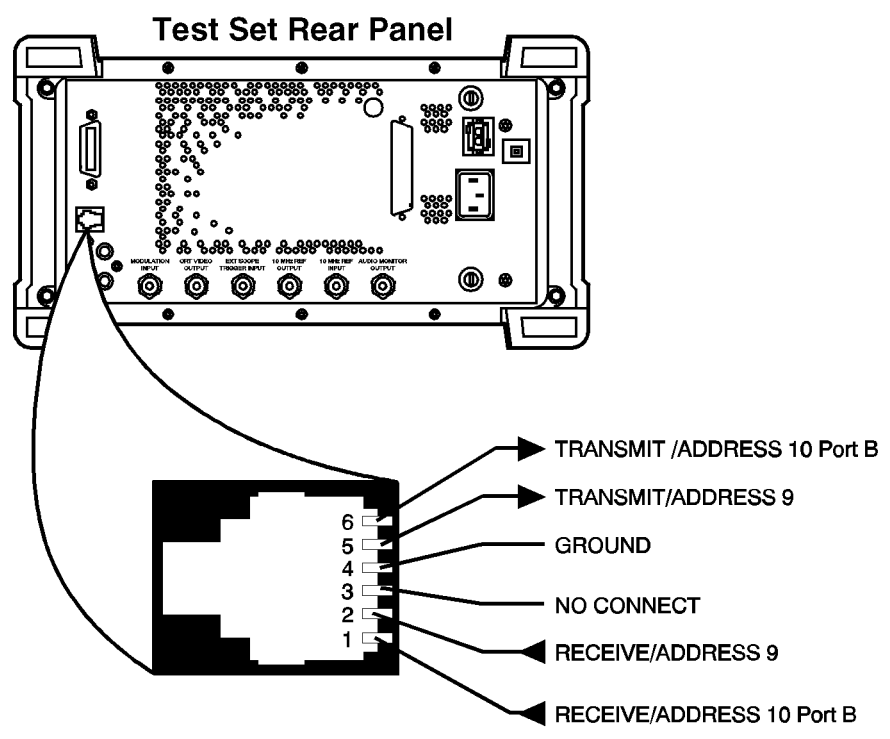

Figure 3 Test Set RJ-11 Serial Port Connections

Test Execution Conditions

In some situations, you may wish to change the way the software works when a test result is obtained. **Test Execution Conditions** allow you to do this.

Test Execution Conditions are accessed from the **SET UP TEST SET** list on the **TESTS (Main Menu)** screen. Press **TESTS**, then select **Execution Cond** to display them. (They are displayed directly on the main **TESTS** screen in firmware below revision A.14.00).

Test Execution Conditions are not retained after a power-down/power-up cycle.

The following **Test Execution Conditions** can be set as needed:

Output Results To: (Output Destination)

You can select either: **Crt** or **Printer** Default:**Crt**

You can specify where test results are to be placed. If you select **Crt**, results will be displayed on the test set's CRT. If you select **Printer**, test results will be sent to the CRT and to a printer. You must connect and configure a printer if you select **Printer**. See "[Printing](#)" on page 225.

Output Results For: (Output Results)

You can select either: **All** or **Failures** Default:**All**

You can specify if you want only the failed results to be displayed or printed. This will be useful if you generally do not print test results, and want to ensure that failed results are displayed or printed.

Output Heading

You can use this field to enter a heading that will be printed or displayed.

Select the **Output Heading** field. Use the knob to choose and enter the characters that you want to appear in the heading.

Choose **Done** when you are finished.

If Unit-Under-Test Fails (If UUT Fails)

You can select either: **Continue** or **Stop** Default: **Continue**

If you set this to **Stop**, and a pass/fail result is **F**, the program will stop.

Test Procedure Run Mode (Run Mode)

You can select either: **Continuous** or **Single Step** Default: **Continuous**

You can make tests pause at certain times. If you set this to **Single Step**, the program will pause after a comparison is made between a test determination and the expected result. For example, tests will pause after the program compares the results to a specification. You can continue from the paused state by pressing k2 (**Continue**).

Autostart Test Procedure on Power-Up

You can select either: **On** or **Off** Default: **Off**

You can set up the test set so that if the procedure was previously loaded, the procedure will be immediately executed when the test set is powered on.

USER Keys

When you are using the test set, you will see the following USER keys assigned appear at times in the top right corner of the display. These keys are assigned to the hard keys k1 through k5. In many cases, these keys can be used as “shortcuts” instead of positioning the cursor and selecting. USER keys are sometimes referred to as softkeys.

Clr Scr clears the test set’s CRT display.

Continue continues the program after it has been paused.

Delet Stp is used to edit items in a test sequence. When you press this key, the test in the displayed sequence that has its **Step #** highlighted (inverse video) will be deleted. The tests that follow in the sequence will be scrolled up by one step.

Del Proc is used to delete the selected procedure. When you press this key, you will be prompted to verify the command by pressing Yes.

Press **Done** when you want to exit a test or have completed a task. The program will continue if there is a next test in the sequence or if there are additional program steps in the test being run.

Help provides information on how to use the current TEST screen.

Init Card is used to initialize a memory card. Before you press this key, verify that the card is inserted correctly and not in the write-protected position.

Insrt Stp is used to enter items into a test sequence. When you press this key, the test in the displayed sequence that has its **Step #** highlighted (inverse video) will be copied into a new sequence location, immediately after the highlighted one. The tests that follow in the sequence will be scrolled down by one step. This key does nothing if there are no items in the sequence. Choose a test before using this key to insert another.

Main Menu is used to return to the main TESTS screen. The same result is achieved by pressing TESTS.

Page Up\Page Down are used to quickly display items in the list when some of the items won’t fit on the screen.

Run starts an IBASIC program that has been loaded into the test set’s memory.

Run Test loads and runs the program that is called from the procedure that has been entered into the TESTS screen **Select Procedure Filename:** entry. If the program is already loaded into the test set's memory, it will be started.

Save Proc is used to save the specified procedure.

Sngl Step steps the IBASIC program one line at a time. This is different from **Continuous/Single Step** run mode. See "**Test Execution Conditions**" on page 250.

Stop Test pauses the test software.

Take It causes the program to accept the setting of an adjustment, and proceed with the program. The test, determining if the adjustment is within limits, is ceased.

Yes\No are pressed when answering questions displayed on the test set's CRT display.

Problem Solving

If You Have a Problem Testing Your Radio

This section contains information for solving some of the most common problems related to using the HP 11807A,E radio-test software. All problems in this section have a single obvious symptom (shown in bold typeface at the top of each page), but many possible causes (listed in order from the most probable cause to the least probable cause).

NOTE:

If the test set displays an error that states “*One or more self- tests failed*”, you have a hardware problem. In this case, refer to the test set’s *Assembly Level Repair* manual.

If the problem has to do with operating the test set, you’ll want to refer to the MESSAGE screen to list errors or operating messages that have occurred since the instrument was turned on. To do this, press the SHIFT and then the MSSG key.

Also, the *HP Instrument BASIC* manual describes any errors that happen as a result of running IBASIC programs.

If the test procedure doesn't run on a test set

- Check to see that the memory card is correctly inserted into the test set.
- Check to see that a test procedure file has been loaded into the test set.

In the upper left corner of the TESTS (Main Menu) screen, a file name should be seen in the **Select Procedure** field. If the field is blank, then a test procedure file has not been loaded.

To load a test procedure file:

1. Press TESTS.
2. Position the cursor to the **Select Procedure Location** (or **Location**) field and choose **Card** from the **Choices** menu.
3. Position the cursor to the **Select Procedure Filename** (or **Procedure**) field and choose the test procedure file you want from the **Choices** menu.

- Check that you have selected k1 (**Run Test**) to start testing.
- Check the MESSAGE screen to see if an error is causing the test procedure to not run.

If you see the error message “Structures improperly matched” or “Improper context terminator”, the software program was incorrectly loaded into the test set. In this case, refer to the directions on the next page.

NOTE:

Test procedure files are not the actual code or program needed to run the tests. You'll need to load the test procedure file, then run the selected tests with the memory card containing the program code inserted in the memory card slot. The program code remains loaded in the test set until another program is loaded.

If the HP 11807A,E program was incorrectly loaded

An error message like “Structures improperly matched” or “Improper context terminator” appears. It takes 2-4 minutes to load an HP 11807A program when k1 (**Run Test**) is first pressed. It takes approximately 15 seconds to load an HP 11807E program. Thereafter, it takes only a few seconds to run.

- Were the SHIFT CANCEL keys pressed or the memory card removed while the program was loading? If this was done, you will need to clear the RAM, or load another program and then re-load the HP 11807A,E program.

To clear RAM in the test set: *(All SAVE registers are lost.)*

1. Press TESTS.
 2. Position the cursor to **Select Procedure Location** and choose **ROM** from the **Choices** menu.
 3. Position the cursor to **Select Procedure Filename** and choose **IB_UTIL** (or **COPY_PL**) from the **Choices** menu.
 4. Press k1 (**Run test**).
 5. Press k5 (**CLEAR RAM**).
 6. Press TESTS, and re-load and run the test procedure you want.
- Check to see that the test set has enough RAM memory. To see if there's enough RAM memory
 1. Press TESTS.
 2. Position the cursor to **Select Procedure Location** and choose **ROM** from the **Choices** menu.
 3. Position the cursor to **Select Procedure Filename** and choose **LIST_OPTS** from the **Choices** menu.
 4. Press k1 (**Run Test**).
 5. If the screen displays **OPTIONAL RAM**, your test set has enough RAM memory. If **OPTIONAL RAM** is not displayed, refer to "**Ordering Upgrades**" on page 17 in [chapter 1](#).

If the printer does not print the test results

- Check that the printer is turned on.
- Check that the HP-IB, parallel, or serial cable from the test set to the printer is connected.

If have firmware below revision A.14.00 OR you are using software with Revision A.xx.xx

1. Press TESTS.
2. Check that **Printer** was selected as the **Output Destination** in the **Test Execution Conditions**.
3. Check that the test set is correctly configured for HP-IB, parallel, or serial printing:

For a HP-IB printer:

- a. Check that the printer's **Calling Name** is "PRINTER" and its address is correctly set up in the External Devices (or Edit Cnfg) screen.
- b. Check that the I/O CONFIGURE screen has been set up correctly:
 - i Mode=Control
 - ii Print To=HP-IB
 - iii Print Adrs=address of your printer

For a parallel printer:

- a. Check that the printer's **Calling Name** is **PRINTER** and its address is set to **15** in the External Devices (or Edit Cnfg) screen.

For a serial printer:

- a. Check that the printer's **Calling Name** is **PRINTER** and its address is set to **9** in the External Devices (or Edit Cnfg) screen.
- b. Check that the I/O CONFIGURE screen has been set up correctly for the printer's baud rate, parity, and so forth.

Refer to the test set's *User's Guide* for details about configuring the printer.

If you have an HP 8920B or HP 8920A,D with firmware above revision A.14.00 AND you are using software with Revision B.xx.xx

1. Press TESTS.
2. Select **Printer Setup** from the **SET UP TEST SET** list.
3. Check that **Printer** was selected in the **Output Results To:**.
4. Check that the test set is correctly configured for HP-IB or serial printing:
 - a. Select **Model** and choose the most compatible printer model from the **Choices** menu.
 - b. Select **Printer Port** and choose which printer port you are using.
 - c. If the HP-IB port was selected, check that the correct **Printer Adrs** was entered.
 - d. If the Serial port was selected, check that the I/O CONFIGURE screen has been set up correctly for the printer's baud rate, parity, and so forth.

Refer to the test set's *User's Guide* for details about configuring the printer.

If you can't get the data-collection function to work

- Check that you have **DATA C** entered in the TESTS (**External Devices**) (or **Edit Config**) menu.
 1. Press TESTS.
 2. Select the External Devices screen, from the **SET UP TEST SET** list (or **Edit Config** from the **Test Function** field).
 3. Position the cursor to the **Calling Name** field, push the knob and enter:
DATA C.
- Check the **Model** field, it should be kept empty since it is not used.
- Check the **Addr** (address) field to make sure the correct address is entered for where the data is to be stored.
 1. If data is to be stored on an SRAM memory card, enter “1” into the **Addr** field.
 2. If data is to be stored on an external computer through the test set's RS-232 serial port (if available), enter “9” into the **Addr** field.
 3. If data is to be stored on an external disk drive over HP-IB, enter an address of “700” or greater into the **Addr** field.
- Check the **Options** field to make sure it is correctly set up:
 1. **For an external disk drive (LIF format) or an SRAM memory card:**
 - a. Enter **ASCII** for saving data as an ASCII file.
 - b. Enter **BDAT** for saving data as a Binary-Data file.
 - c. As an option, you may enter **REC=xxx**, where “xxx” is the number of records for each file. (*The software defaults to 80 records. However, if too small a record size is used, you'll get an “End of file error” when the test is run.*)
 2. **For a DOS disk drive, you may keep the Options field empty, or you may enter any of the following key words:**
 - a. Enter **ASCII** for saving data as an ASCII file.
 - b. Enter **BDAT** for saving data as a Binary-Data file.
 - c. Enter **REC=xxx** for the file's record size, where “xxx” is the number of records for each file. (*The software defaults to 80 records. However, DOS systems automatically change record size if it's too small.*)
 - d. Enter a (**dot extension**) of 3 characters or less for the file name. For example, all model ABCD radio's tested may be organized to have a “.ABC” file extension.

- Check the test set to make sure it's in the controller mode *if you are using an external disk drive*.
- 1. Access the I/O Configure screen from the **More** field in the **To Screen** menu.
- 2. Position the cursor to the **Mode** field and select **Control**.

NOTE:

When the test operator is prompted to enter a file name where data is to be stored, the protocol for the mass-storage device being used must be followed.

Hierarchical directory paths are not allowed, and all files are created with "FORMAT ON".

Also, when initializing a disk, use the following format ("7xx" is the disk address, "y" is the device selector):

DOS disk: **INITIALIZE "DOS:CS80,7xx,y"**

LIF disk: **INITIALIZE ":,7xx,y"**

If the cellular phone fails to obtain service

- Check test **Parameter 4. CP Control Channel** to make sure it is set to the correct control channel for which your cellular phone is programmed to use. The range of control channels for phones programmed to use the “A band” is 313-333. The range of control channels for phones programmed to use the “B band” is 334-354.
- Check the antenna connection on the cellular phone. The cellular phone’s antenna should be connected to the test set RF IN/OUT connector and not to the DUPLEX OUT connector.
- Check that the cellular phone is on frequency with the test set’s timebase.

The test set Option 001 High-Stability Timebase is recommended for cellular phone testing.

If your test set is equipped with Option 001, use a frequency counter to ensure that the High-Stability timebase is on frequency.

If the cellular phone registers, but won't page

- Check the cellular phone to see if it is the type with all zeros in its Mobile Identification Number (MIN). In some cases, new cellular phones have not been programmed with a MIN number.

If it is, set parameter 3 **CP all zero MIN number** to 1 (for yes).

If the cellular phone fails the audio tests

- Check the specifications for the cellular phone to make sure they match with those entered in the HP 11807A,E software Pass/Fail Limits.

Select **Pass/Fail Limits** from the **Customize Test Procedure** list (or **Edit Spec** from the **Test Function** field), and note the limits that have been entered for the corresponding audio specifications.

- Check the audio connections from the cellular phone to the test set. Refer to [page 29](#) to view the interconnection diagram in [chapter 2](#) for details.

- Check the cellular phone to make sure the microphone is not active. (Mute the microphone input).

For a handset type phone, make sure the handset is on the “hook”.

For a handheld type phone, make sure the handheld is muted

- Check the cellular phone to see if the audio lines carry other signals.

For example, if the audio lines carry other dc signals, a blocking capacitor in series with the test set is required.

If a cellular phone links up with a system, not the test set

- Check to see if the testing area is in the proximity of a cell site.

Corrective action:

Raise the signal level of **Parameter 22. RX RF Level for Signaling** to overpower the external cell-site signal.

- Check to see if the cellular phone's antenna connector is connected to the test set RF IN/OUT connector.

Corrective action:

Connect a cable from the cellular phone to the test set RF IN/OUT connector.

Glossary

CANCEL A key used to pause (stop) the IBASIC program running in the test set.

card Refers to the memory card containing the procedures for testing the unit-under-test.

Choices Refers to a field in the lower right of the screen that displays several possible functions for selection.

Continue Proceed with the IBASIC software program if it has been stopped (paused).

cursor Refers to the brightened region of the screen used to indicate the field/function currently being accessed.

Del Step A function to delete a step in the procedure.

Disp Loc A menu function which presents an assembly diagram that displays location of the adjustable component.

ESD ElectroStatic Discharge - A transfer of electric charge from one place to another. Devices can be damaged by the energy transferred during the discharge.

field An area on the CRT with an inverse video display (**example**) where entries can be made.

function Refers to a particular field, feature, or operation of the test set.

Help A feature providing specific information about how to use the current screen in the TESTS environment. This feature is accessed by pressing k4 (**Help**) from any TEST screen. Note: only available

in the HP 8920B and HP 8920A,D firmware above revision A.14.00.

HELP A feature providing additional test set information accessed by pressing SHIFT, then TX (HELP) keys. Help topics are listed in alphabetical order.

highlight Refers to the brightened region (cursor) of the screen used to indicate the field/function currently being accessed.

IBASIC Instrument BASIC is the computer language (code or software) used by the test set's built-in controller. The IBASIC software is downloaded from the OTP CARD into the test set's RAM. This software is then used to control the test set during autotesting the unit-under-test.

initialize A card or disk must be formatted prior to storing data. This may be done by pressing k3 (**Init Card**) on the TESTS (**Save/Delete Procedure**) screen. The default for PCMCIA cards (HP 11807E) is DOS format, and for Epson Cards (HP 11807A,B) is LIF format. See "**Memory Cards**" on page 214 Memory Cards in chapter 4 for information on changing these default settings.

key (USER keys) Keys refer to any of the push buttons on the front panel of the test set. The USER keys are a specific grouping of keys labeled k1 to k5 which perform the associated numbered function in the action field located in the upper right of the screen. The USER keys are user programmable.

Glossary

knob The large tuning dial for cursor control located in the center of the test set front panel. This knob is rotated to position the cursor on the screen and then pressed to select the particular field or function.

library A collection of the names of all of the parameters, pass/fail limits, and tests in the test software. The test software and the test set's firmware use the library, test software program code file, and a procedure to run a customized application program. A library is stored as a file on a memory card or other mass storage with its associated procedure files.

Location Where to retrieve or save a particular testing procedure, for example, to a disk, card, RAM, or PC.

measurement A series of calculations on data measured by the test set. These calculations provide a value to be compared against pass/fail limit values that verify the performance of the unit-under-test.

Main Menu The screen accessed by pressing the TESTS key, or k5 (**Main Menu**). It is used to customize and execute (run) automated testing.

Also referred to as the "TESTS" screen.

menu The test set's screen displays various tasks to be selected with the cursor control knob or the USER keys ; this display is the menu.

message The upper portion of the test set's screen is reserved for messages and prompts. Messages give an indication of the status of the test set, for example, **System initialization**.

OTP One Time Programmable (OTP) refers to a CARD on which code or data may only be stored once; similar to ROM. The HP 11807A/E software is shipped on an OTP memory card.

parameters Entries you make for calibration data, phone characteristics, or test customization. They give you flexibility in the way you use the software. Default values for parameters are present in the software.

pass/fail limits Pass/fail limits are the names of criteria verifying the performance of the unit-under-test. Usually, the associated measurement value must fall within the HI/LO limits of pass/fail values to verify performance of the unit-under-test. Default values in the test software have been derived from standard methods of measurement or from the unit-under-test requirements.

pause Using the CANCEL key pauses the running of IBASIC software in the test set and allows access to the keyboard functions. CONTINUE allows the software to proceed.

peak+/- max A detector in the test set that measures and computes the maximum of the absolute value of the positive and negative excursions of the measurement. For example, when an FM waveform with a +10 kHz and -9 kHz deviation is applied, 10 kHz will be displayed.

PRESET Sets the test set to its initial power-up state.

Glossary

procedure A shortened label for test procedure. A procedure is a collection of channels, parameters, pass/fail limits, and testing order, saved in a file, that customizes the test software to a specific application. Procedures are made by editing existing channels, parameters, pass/fail limits, and testing order, and saving the resulting files to a memory card, disk or internal test set RAM.

prompts The upper portion of the test set (inverse video field) is reserved for prompts and messages. The prompt directs the user to take some action. Messages give an indication of the status of the test set.

RAM Random Access Memory - The memory in the test set that is used to store program code and data. The test set's RAM is battery-backed-up, retaining data and program codes when the power is turned off.

ROM Read Only Memory

Run Test Directs the test set to load the program from the current procedure and begin testing (may take up to two minutes).

save Save and store are used synonymously and refer to putting data or software on some memory device, such as, card or RAM.

screen Refers to the video display of the test set.

select To choose a particular field or function. Rotate the CURSOR CONTROL knob and position the highlighted cursor on the chosen field or function, then press the knob. An alternative method is to press the numbered USER key having the same number as displayed alongside the desired function.

softkey The name of the set of keys next to the CRT display that can be assigned to certain special actions or fields. The keys are also called USER keys.

SRAM Static Random Access Memory - A data storage device. SRAM memory cards can be used with the test set to save programs and test results.

Step Orders the sequence of tests, e.g. Step 1 may be Test_5, and Step 2 may be Test_26 and so on.

store Store and save are used synonymously and refer to putting data or software on some memory device, such as card, RAM.

tests Tests are a collection of measurements (or a series of other tests) which verify a particular specification value or operation of the UUT. A sequence of tests are contained in a test procedure.

TESTS screen The screen accessed by pressing the TESTS key. It is used to customize and execute (run) all automated testing. Also referred to as the "Main Menu".

Glossary

USER keys A group of keys located immediately to the right of the test set's screen that allow the user to more rapidly select certain functions without rotating and pressing the knob. These key assignments are displayed in the upper right portion of the test set's screen. The number on the left of the function corresponds to the number on the user key k1 to k5.

values The scalar quantities or numbers inserted in the inverse video fields of the pass/fail limits or parameters. Units of measure (dB, inches, volts, watts, etc.) are contained in the pass/fail limits and test parameters.

Numerics

1-800 help line, 21

A

AA Enter Ph#?
parameter description, 128
AC MIN From?
parameter description, 130
additional services available, 21
AdvanceLink, 204
ALERT order
to the UUT, 91
AMPS standard, 106
antenna
connection on the phone, 263
Area Identification Number (AID)
test parameter, 129
ASCII file type, 200
attenuator loss, 17
attenuators
connected to test set, 136
audio connections
from the cellular phone, 265
audio distortion
pass/fail limit, 171
audio distortion test
for receiver, 112
for transmitter, 98
audio frequency response test
for receiver, 111
for transmitter, 97
audio level
setting it, 149
audio lines
carry other dc signals, 265
audio output flatness, 97
audio power
rated, 148
audio response deviation
pass/fail limit, 164, 172
audio response frequencies
test parameters, 142, 150
audio tests
if the cellular phone fails, 265
Autostart, 86
Autostart Test Procedure on Power-Up,
251

B

bandpass filter (BPF)
6 kHz, 17
6 kHz option, 101
BCH error detection, 91
BDAT file type, 200
Binary-Weighted Decimal (BWD), 151,
153
BWD (Binary-Weighted Decimal), 151,
153

C

cable loss
 for pads and cables, 17
 CANCEL, 224, 267
 capacitor
 dc blocking, 265
 card
 how to insert, 28, 62
 carrier power at levels 0-7
 pass/fail limit, 173
 CAT IBASIC command, 197
 CCITT filter, 112
 cell site release, 117
 cell-site signal
 to overpower the external, 266
 cellular phone
 antenna connection on the, 263
 audio connections, 265
 audio tests, 265
 can't link up with test set, 266
 MIN number, 264
 registers, but won't page, 264
 won't roam if its off frequency, 263
 Changing the Order of Tests, 34
 channel information
 general description, 38
 securing, 244
 channel numbers
 specifying information, 38, 72
 chng chan
 on flowchart, 123
 chng pwr
 on flowchart, 123
 chng sat/dsat
 on flowchart, 123
 Choices, 196, 267
 choose, 196
 Class II and III radios, 94
 clear ls
 on flowchart, 123
 clear ms
 on flowchart, 123
 Clr Scr, 252
 C-Message filter, 16, 112
 compandor is always on
 test parameter, 135
 compressor
 zero reference deviation, 106

compressor levels
 test parameters, 152
 compressor response test
 for transmitter, 106
 compressor tracking error
 pass/fail limit, 176
 compressor zero-reference deviation
 NTACS pass/fail limit, 183
 pass/fail limit, 177
 configuration
 for data collection, 199
 for terminal or PC operation, 207
 CONFIGURE screen
 for printer, 259
 configuring an IBM-compatible PC with
 HP AdvanceLink, 204
 connecting
 the radio, 28, 62
 connecting a printer, 226
 connections
 parallel printer, 227
 RJ-11 connector, 226
 serial printer, 226
 Continue, 252, 267
 Continue USER key, 224
 continuing a paused program, 224
 control channel
 test parameter, 131
 conventions used, 196
 COPY IBASIC command, 197
 COPY_PL program, 258
 copying files, 197
 current drain at levels 0-3
 pass/fail limit, 178
 current drain at levels 4-7
 pass/fail limit, 179
 current drain levels tested
 test parameter, 153
 current drain test
 for transmitter, 107
 current measurement, 17
 current-measuring circuit, 107
 cursor, 267
 customizing testing, 32, 66

D

data collection
 description, 199
 entering the configuration for, 199
 example configuration, 200
 memory card part numbers, 215
 retrieving data, 202, 210, 218
 saving to a memory card or disk, 199
 to a PC, 204
 to a PC, setting up, 206
 dc blocking capacitor, 265
 DC Current Measurement connectors, 17
 de-emphasis
 test parameter, 154
 de-emphasis curve, 111, 164
 Del Proc, 252
 Delet Stp, 252, 267
 deleting a procedure, 243
 disk
 initializing, 209
 retrieving data from, 210
 disk drive
 External Disk Specification, 240
 disk formats, LIF and DOS, 200
 distortion
 audio, 98
 distortion and noise, 114
 distortion, audio
 pass/fail limit, 171
 Done, 252
 DOS disk format, 200
 DOS file type, 200
 DSAT vector
 test parameter, 132
 DTMF frequency error
 pass/fail limit, 180
 DTMF frequency error test
 for transmitter, 126
 DUPLEX OUT
 connector, 263

E

Edit Configuration
 data collection to a PC, 206
 Edit Frequency, 38, 72
 Edit Parameter, 48, 80
 Edit Seqn field, 89
 Edit Sequence, 68
 Edit Spec, 222
 Edit Specifications, 45, 77
 EIA standards
 for FM tests, 89
 enter, 196
 ENTER key, 196
 equipment
 included, 16
 error
 Improper context terminator, 258
 improper context terminator, 257
 Structures improperly matched, 258
 structures improperly matched, 257
 errors
 from hardware problems, 256
 from IBASIC, 256
 from operating HP 8920A, 256
 on MESSAGE screen, 256
 escape sequences, 230
 rev B software with fw below A.14.00,
 236
 exiting a program, 212
 expander
 zero reference level, 110
 expander levels
 test parameters, 143
 expander test
 for receiver, 110
 expander tracking error
 pass/fail limit, 165
 expander zero-reference level
 pass/fail limit, 166, 168
 external path loss
 test parameter, 136

F

Factory Hot Line, 21
 field, 267
 selecting a, 196
 file name
 disk example, 210
 file types, ASCII, BDAT, DOS, and HP-
 UX, 200
 files
 copying, 197
 filter
 6 kHz Bandpass, 16
 C-Message, 16
 flash
 memory cards, 214
 flow-chart test, 122
 FM hum and noise
 pass/fail limit, 181
 FM hum and noise test
 for transmitter, 100
 Forward Voice Channel (FVC), 91
 Forward Voice Control (FVC)
 order message, 169
 frequency
 editing values, 38, 72
 general description, 72
 frequency counter
 to put timebase on frequency, 263
 frequency deviation
 caused by audio to UUT, 96
 frequency deviation step frequency
 test parameter, 155
 frequency error
 pass/fail limit, 182
 frequency error test
 for transmitter, 92
 front-panel control characters, 207
 FVC message error rate RF level
 test parameter, 144
 FVC Order Message error rate test
 for receiver, 116

H

handoffs, 122
 handset
 type of phone, 265
 hardware configurations, 16
 hardware errors, 256
 Help, 252
 high-pass filter, 156
 High-Stability timebase
 for cellular radio testing, 263
 use a frequency counter, 263
 high-supply voltage
 test parameter, 137
 hook flash test, 125
 hook flashes, 122
 HP-IB
 power supply, 17
 HP-IB control annunciators, 213
 HP-IB printer, 228, 259
 HP-IB printer connections, 226
 HP-UX file type, 200
 hum and noise
 pass/fail limit, 167
 hum and noise test
 for receiver, 113
 for transmitter, 100

I

IBASIC, 267
 copying files, 197
 errors, 256
 initializing a disk, 209
 initializing RAM, 246
 retrieving data from a card, 203, 219
 retrieving data from a disk, 210
 TESTS screen, 32, 66
IBASIC commands
 entering from a terminal, 197
If Unit-Under-Test Fails, 251
If Unit-Under-Test-Fails, 54
If UUT Fails, 251
Improper context terminator
 error, 258
improper context terminator
 error, 257
industry standards, 89
Init Card, 252
initializing, 267
initializing a disk, 209
initializing an SRAM memory card, 217
initializing RAM disks, 246
Insrt Stp, 252
instantaneous frequency deviation, 96

L

library, 268
 definition, 50, 82
 saving, 50, 82, 240
LIF disk format, 200
loading a procedure, 242
loading software, 28, 62
Location, 31, 65, 268
low-supply voltage
 test parameter, 138

M

Main Menu, 252, 268
maintenance mode, 99
maintence
 on flowchart, 123
Manchester-encoded data, 103
measurements, 90, 268
memory card, 267
memory cards
 are used for, 214
 determining whether it is OTP, flash, or
 SRAM, 214
 flash, 214
 how they're powered, 214
 initializing, 217
 inserting, 214
 OTP, 16, 214
 removing, 215
 retrieving data from, 202, 218
 saving data to, 199
 software, 28, 62
 SRAM, 16, 214
 Static Random Access Memory
 (SRAM), 215
 storage space needed, 216
 write protect switch, 216
MESSAGE screen errors, 256
microphone
 affected by noise, 101
 make sure it's not active, 265
 sensitivity, 160
mobile identification number, 264
modulation deviation limit 50 Hz HPF
 test parameter, 156
modulation deviation limiting test
 for transmitter, 96
modulation distortion, 171

N

NAM
 Number Assignment Module, 91
 No, 252
 no audio functional tests, 119
 NO SERVICE indicator, 118
 noise
 into an open microphone, 101
 noise and distortion, 114
 nominal-supply voltage
 test parameter, 139
 non-return to zero (NRZ), 103
 NTACS DSAT closure
 pass/fail limit, 184
 NTACS DSAT deviation
 pass/fail limit, 185
 NTACS DSAT phase jitter
 pass/fail limit, 186

O

OMER
 pass/fail limit, 169
 On UUT Failure, 86
 operating errors, 256
 Optional RAM message, 258
 order message, 133
 order message error rate
 pass/fail limit, 169
 order of tests
 printing, 225
 saving, 241
 order-confirmation message, 133
 ordering upgrades, 17
 order-message error-rate test, 116
 origination message, 133
 origination test
 call processing, 118
 OTP
 memory cards, 214
 OTP card, 268
 OTP memory cards, 16
 Output Destination, 86, 250
 Output Heading, 54, 86, 250
 output power levels tested
 test parameter, 151
 output power test, 94
 Output Results, 86, 250
 Output Results For, 54, 250
 Output Results To, 54, 250

P

Page Down, 252
 Page field, 122
 page test, 91
 Page Up, 252
 page-response message, 133
 paging
 and access channels, 103
 parallel printer connections, 227
 parameters, 268
 editing values, 48, 80, 220
 general description, 48, 80, 220
 printing, 225
 saving, 50, 82, 220, 241
 securing, 244
 part numbers
 memory card battery
 memory cards
 SRAM battery part number,
 215
 software memory cards, 16
 SRAM Memory Cards, 215
 pass number, 244
 pass/fail limits, 268
 default values, 162
 descriptions, 162
 editing values, 45, 77, 223
 general description, 45, 77, 222
 printing, 225
 saving, 222, 241
 securing, 244
 pause, 268
 pausing a test, 224
 PC
 collecting data to, 204
 peak frequency deviation
 NTACS pass/fail limit, 187
 pass/fail limit, 188
 phone
 antenna connection on the, 263
 audio connections, 265
 audio tests, 265
 can't link up with test set, 266
 MIN number, 264
 registers, but won't page, 264
 won't roam if its off frequency, 263
 phone number, 91

how to enter, 128
phone paging, 122
phone registration, 122
power class, 91
power measurement
 units for measuring RF power, 159
power output test, 94
power supplies, 17
power supply
 configuring external, 17
 current, 107
 HP-IB supported supplies, 17
power-level changes, 122
power-supply current, 107
predistortion, 106, 110
pre-emphasis curve, 172
pre-emphasis slope, 97
PRESET, 28, 62, 268
print options
 pitch, margins, paper size, typeface,
 230, 236
printer
 does not print, 259
 HP-IB, 228
 HP-IB or serial, 259
 output heading, 250
 serial, 228
printers supported, 225
printing, 225
 test results, 250
 test results using firmware above revision A.14.00, 229
 test results using firmware below revision A.14.00, 235
 TESTS Screens, 233, 239
 using A.xx.xx revision software, 228
procedure, 31, 65, 90, 269
 deleting, 243
 general description, 50, 82, 240
 loading into test set memory, 242
 names, 240
 saving, 50, 82, 240
 securing, 244
 un-securing, 245
 what is saved, 240
program
 exiting a program, 212
 incorrectly loaded, 258

stored in test set memory, 215
programmable power supplies, 17

Q
quick general tests
 for receiver, 121
 for transmitter, 120

R

radio
 connecting, 28, 62
 radio standards
 for FM, 89
 RAM, 269
 disk, 246
 initializing, 246
 memory expansion, 16
 RAM memory
 enough for the test set, 258
 REC=
 default entry, 200
 entering record number, 200
 to set record size, 200
 RECC message, 118, 133
 RECC RCV Data
 test parameter, 133
 receiver
 quick general tests, 121
 receiver hum and noise, 113
 receiver sensitivity, 114
 Regist field, 122
 registration test, 91
 release test
 call processing, 117
 retrieving data from a memory card, 202
 Reverse Control Channel (RECC), 91
 Reverse Control Message, 91
 RF level
 for signaling, 111
 RF level for signaling
 test parameter, 145
 RF level for signalling
 parameter, 266
 RF level for SINAD
 test parameter, 146
 RF level for SINAD, at extremes
 test parameter, 147
 RF power
 units for measuring, 159
 RF power output test, 94
 RF sensitivity, 170
 RF signal level, 145
 RJ-11 connectors, 248
 rms detector, 99
 rms deviation, 106
 roam

if the phone won't, 263
 ROAM indicator
 for origination, 118
 ROM, 269
 Run, 252
 Run Mode, 86, 251
 Run Test, 252, 269
 difference between Run and, 203, 219
 running tests, 24
 overview, 26, 60

S

SAT changes, 122
 SAT deviation
 pass/fail limit, 189
 SAT frequency error, 124
 pass/fail limit, 190
 SAT frequency error and Deviation test
 for transmitter, 101
 SAT tone
 test parameter, 134
 SAT tones, 101
 save, 269
 SAVE IBASIC command, 197
 Save Proc, 252
 SAVE registers lost, 258
 saving
 procedure, 50, 82
 test procedure, 50
 test results, 199
 saving a procedure, 240
 SECURE IT ROM program, 244
 securing a procedure, 244
 select, 196, 269
 sensitivity
 for the receiver, 114, 170
 sequence
 changing, 34
 editing, 68
 general description, 34, 68
 saving, 50, 82
 serial number, 91
 Serial Port, 248
 serial port connections
 figure, 249
 serial printer, 228, 259
 serial printer connections, 226
 set audio level
 test parameter, 148
 Setting, 62
 signaling tone (ST), 99
 signaling tone deviation
 pass/fail limit, 191
 signaling tone frequency
 pass/fail limit, 192
 signaling tone test
 for transmitter, 99
 signaling, tone/digital, 17
 SINAD

-
- pass/fail limit, 170
 - SINAD test
 - for receiver, 114
 - Sngl Step, 252
 - softkeys, 252, 269
 - software
 - features, 19
 - how to load, 31, 65
 - loading, 28, 62
 - overview, 26, 60
 - stopping the, 224
 - software revision A.xx.xx
 - printer setup, 228
 - special display conventions used, 196
 - specifications
 - editing values, 45, 77
 - general description, 45, 77, 222
 - saving, 50, 82
 - specifying channel information
 - general description, 38, 72
 - SRAM, 269
 - memory cards, 214, 215
 - SRAM memory cards, 16
 - standards
 - for FM tests, 89
 - steady-state frequency deviation, 96
 - Stop Test, 252
 - stopping a test, 224
 - stopping the program
 - using Test Execution Conditions, 54, 86, 250
 - Structures improperly matched error, 258
 - structures improperly matched error, 257
 - subscriber-unit
 - control functions, 103
 - switch channels
 - test parameters, 157
 - switch channels test
 - for transmitter, 124
 - system ID, 91
- T**
- Take It, 252
 - terminal emulator, 210
 - configuration, 207
 - DataStorm Technologies, Inc. Pro-Comm, 204
 - HP AdvanceLink, 204
 - test at extreme settings
 - test parameter, 140
 - Test Execution Conditions, 54, 86, 250
 - Test Function, 66
 - Edit Frequency, 72
 - Edit Parameter, 48, 80
 - Edit Sequence, 68
 - Edit Specifications, 45, 77
 - Procedure Manager, 50, 82
 - test parameters
 - default values, 127
 - descriptions, 127
 - editing values, 220
 - general description, 220
 - test procedure, 50
 - saving, 240
 - Test Procedure Run Mode, 54, 251
 - test procedures
 - don't run, 257
 - to load, 257
 - test results
 - output failures, 250
 - printing using firmware above revision A.14.00, 229
 - printing using firmware below revision A.14.00, 235
 - retrieving from a disk, 210
 - retrieving from a memory card, 202, 218
 - saving, 199
 - where sent, 250
 - test time, 224
 - testing order
 - securing, 244
 - tests, 269
 - entering a sequence of, 34, 68
 - environment and conditions, 48, 80
 - list of available, 18
 - pausing or stopping, 224
 - reference information, 89
 - required order, 90
 - running, 24
 - TESTS (Pass/Fail Limits) screen
 - entering into, 223
 - TESTS screen, 269
 - timebase
 - High-Stability, 16
 - tolerance for setting audio level
 - test parameter, 149
 - tone/digital signaling, 17
 - tracking error, 106, 110
 - pass/fail limit, 165
 - transmission
 - continuous or discontinuous, 91
 - transmitter
 - quick general tests, 120
 - transmitter current, 107
 - transmitter distortion, 171
 - TXT transient/steady state RVC data parameter, 161
-

U

upgrades,ordering, [17](#)
use DUPLEX OUT & ANT IN
test parameters, [141](#)
USER keys, [196](#), [252](#), [270](#)
UUT phone number
how to enter, [128](#)
UUT volume level, [149](#)

V

voice channels
for handoff, [103](#)
voltage for compressor zero crossing
test parameter, [160](#)
volume level
on the UUT, [149](#)

W

wideband data
displayed by flowchart, [122](#)
wideband data deviation
pass/fail limit, [193](#)
wideband data deviation test
for transmitter, [103](#)
wideband data deviation transient
pass/fail limit, [194](#)
wideband data stream, [133](#)

Y

Yes, [252](#)

Z

zero reference level
for expander, [110](#)